



Planning Commission Staff Report

Meeting Date: February 5, 2019

Agenda Item: 9C

MASTER PLAN AMENDMENT CASE NUMBER: WMPA18-0009 (1015 US Highway 395 S)
REGULATORY ZONE AMENDMENT CASE NUMBER: WRZA18-0008 (1015 US Highway 395 S)

BRIEF SUMMARY OF REQUEST: To adopt an amendment to the Washoe County Master Plan South Valleys Area Plan and amend the South Valleys Regulatory Zone Map for a ±2.56-acre parcel

STAFF PLANNER:

Planner's Name: Julee Olander
Phone Number: 775.328.3627
E-mail: jolander@washoecounty.us

CASE DESCRIPTION

For possible action, hearing, and discussion to initiate and adopt an amendment to:

(1) To adopt an amendment to the South Valleys Area Plan, a component of the Washoe County Master Plan, to add the Master Plan Category of Rural (R) on a ±2.56 acre parcel that was previously part of the Nevada State Department of Transportation (NDOT) right-of-way and currently has no assigned Master Plan Category, and, if approved, authorize the chair to sign a resolution to this effect; and

(2) Subject to final approval of the associated Master Plan Amendment change and a finding of conformance with the 2012 Truckee Meadows Regional Plan, to recommend adoption of an amendment to the South Valleys Regulatory Zone Map, to add the Regulatory Zone of General Rural (GR) on a ±2.56 acre parcel that was previously part of the Nevada State Department of Transportation (NDOT) right-of-way and currently has no assigned Regulatory Zone, and, if approved, authorize the chair to sign a resolution to this effect.

Applicant:	Washoe County
Property Owners:	Michael D & Penny L Sayan
Location:	1015 US Highway 395 S
APN:	046-051-49
Parcel Size:	±2.56 acres
Master Plan:	Not Assigned
Regulatory Zone:	Not Assigned
Area Plan:	South Valleys
Citizen Advisory Board:	South Truckee Meadows/Washoe Valley
Development Code:	Authorized in Article 820, Amendment of Master Plan; and Article 821, Amendment of Regulatory Zone
Commission District:	2 – Commissioner Lucey

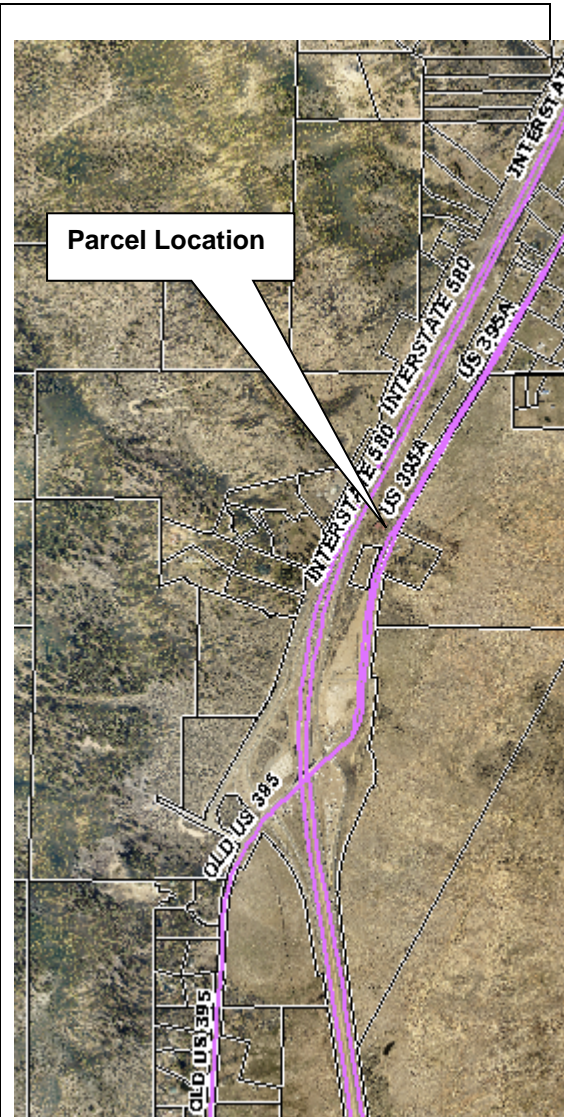

MASTER PLAN AMENDMENT STAFF RECOMMENDATION

INITIATE / APPROVE

INITIATE AND RECOMMEND APPROVAL

DENY

POSSIBLE MOTION

I move that, after giving reasoned consideration to the information contained in the staff report and information received during the public hearing, the Washoe County Planning Commission adopt the resolution contained at Exhibit A to this staff report to amend the Master Plan as set forth in Master Plan Amendment Case Number WMPA18-0009 having made the following five findings in accordance with Washoe County Code Section 110.820.15(d) and the findings required by South Valleys Area Plan Policy SV.29.1 and SV.29.3.

(Motion with Findings on Page 15)

REGULATORY ZONE AMENDMENT STAFF RECOMMENDATION

INITIATE / APPROVE

INITIATE AND RECOMMEND APPROVAL

DENY

POSSIBLE MOTION

I move that, after giving reasoned consideration to the information contained in the staff report and information received during the public hearing, the Washoe County Planning Commission adopt the Regulatory Zone Amendment Case Number WRZA18-0008, having made all of the following findings in accordance with Washoe County Code Section 110.821.15(d).

(Motion with Findings on Page 16)

Staff Report Contents

Explanation of a Master Plan Amendment4

Explanation and Processing of a Regulatory Zone Amendment.....5

Vicinity Map6

Background.....7

Existing and Proposed Master Plan Designation.....8

Existing and Proposed Regulatory Zoning8

Consistency with Master Plan and Regulatory Zone Map9

Compatible Land Uses.....10

South Truckee Meadows/ Washoe Valley Citizen Advisory Board (STMWV CAB).....11

Public Notice.....11

Agency Comments.....11

Staff Comment on Required Master Plan Amendment Findings.....12

Staff Comment on Required Regulatory Zone Amendment Findings13

Recommendation.....14

Master Plan Amendment Recommended Motions15

Regulatory Zone Amendment Recommended Motions16

Appeal Process.....17

Exhibit Contents

Master Plan Amendment ResolutionExhibit A

Regulatory Zone Amendment ResolutionExhibit B

Approved Unbuilt Map for South Valleys Exhibit C

Recorded Documents and Maps..... Exhibit D

South Truckee Meadows/ Washoe Valley Citizen Advisory Board MinutesExhibit E

Noticing MapExhibit F

Agency Comments..... Exhibit G

Explanation of a Master Plan Amendment

The purpose of a Master Plan Amendment application is to provide a method of review for requests to amend the Master Plan.

The Master Plan guides growth and development in the unincorporated areas of Washoe County, and consists of three volumes. By establishing goals and implementing those goals through policies and action programs, the Master Plan addresses issues and concerns both countywide and within each community. Master Plan amendments ensure that the Master Plan remains timely, dynamic, and responsive to community values. The Washoe County Master Plan can be accessed on the Washoe County website at <http://www.washoecounty.us>, select Departments, Planning and Building, then Planning Documents (Master Plan, Regulatory Zone) - or it may be obtained at the front desk of the Washoe County Planning and Building Division.

Volume One of the Master Plan outlines six countywide priorities through the year 2025. These priorities are known as Elements and each is summarized below. The Land Use and Transportation Element, in particular, plays a vital role in the analysis of a Master Plan Amendment.

- **Population Element.** Projections of population, housing characteristics, trends in employment, and income and land use information for the County.
- **Conservation Element.** Information, policies and action programs, and maps necessary for protection and utilization of cultural and scenic, land, water, air and other resources.
- **Land Use and Transportation Element.** Information, policies and action programs, and maps defining the County's vision for development and related transportation facilities needed for the forecasted growth, and protection and utilization of resources.
- **Public Services and Facilities Element.** Information, policies and action programs, and maps for provision of necessary services and facilities (i.e. water, sewer, general government and public safety facilities, libraries, parks, etc.) to serve the land use and transportation system envisioned by the County.
- **Housing Element.** Information, policies and action programs, and maps necessary to provide guidance to the County in addressing present and future housing needs.
- **Open Space and Natural Resource Management Plan Element.** Information, policies and action programs, and maps providing the necessary framework for the management of natural resources and open spaces.

Volume Two of the Master Plan consists of 13 Area Plans, which provide detailed policies and action programs for local communities in unincorporated Washoe County relating to conservation, land use and transportation, public services and facilities information, and maps.

Volume Three of the Master Plan houses Specific Plans, Joint Plans and Community Plans that have been adopted by the Washoe County Board of County Commissioners. These plans provide specific guiding principles for various districts throughout unincorporated Washoe County.

Requests to amend the Master Plan may affect text and/or maps within one of the six Elements, one of the 13 Area Plans, or one of the Specific Plans, Joint Plans or Community Plans. Master Plan Amendments require a change to the Master Plan and are processed in accordance with Washoe County Chapter 110 (Development Code), Article 820, *Amendment of Master Plan*.

When making a recommendation to the Washoe County Board of County Commissioners to adopt a Master Plan amendment, the Planning Commission must make at least three of the five findings as set forth in Washoe County Code (WCC) Section 110.820.15(d). If a military installation is required to be noticed, then an additional finding of fact pursuant to WCC Section 110.820.15(d)(6) is required. If there are findings relating to Master Plan amendments contained in the Area Plan in which the subject property is located, then the Planning Commission must also make all of those findings. A recommendation to adopt the Master Plan amendment requires an affirmative vote of at least 2/3's of the Planning Commission's total membership.

If adopted by the Planning Commission, it will then need to be adopted by the Washoe County Board of County Commissioners. After which it will then require conformance review with Truckee Meadows Regional Plan.

This master plan amendment is proposing to establish 2.56 acres as designated Rural (R) category.

Explanation and Processing of a Regulatory Zone Amendment

The following explains a Regulatory Zone Amendment, including its purpose and the review and evaluation process involved for an application with such a request.

The purpose of a Regulatory Zone Amendment (RZA) is to provide a method for amending the Regulatory Zone Maps of Washoe County. The Regulatory Zone Maps depict the Regulatory Zones (i.e. zoning) adopted for each property within the unincorporated area of Washoe County. The Regulatory Zones establish the uses and development standards applied to each property.

Regulatory zones are designed to implement and be consistent with the Master Plan by ensuring that the stability and character of the community will be preserved for those who live and work in the unincorporated areas of the County. A regulatory zone cannot be changed if it conflicts with the objectives or policies of the Master Plan, including area plans that further define policies for specific communities. The Master Plan is the blueprint for development within the unincorporated County. Pursuant to NRS 278, any action of the County relating to zoning must conform to the Washoe County Master Plan.

Evaluation of the proposed Regulatory Zone Amendment involves review for compliance with countywide policies found in Volume One of the Washoe County Master Plan and applicable area plan policies found in Volume Two of the Washoe County Master Plan. If the subject parcel(s) is within a Specific Plan, Joint Plan or Community Plan found in Volume Three of the Master Plan, then supplemental review shall be required to ensure compliance with the applicable plan. Additionally, the analysis includes review of the proposed amendment against the findings found in Article 821 of the Washoe County Development Code and any findings as set forth in the appropriate Area Plan.

Requests to change a regulatory zone affecting a parcel of land or a portion of a parcel are processed under Article 821, Amendment of Regulatory Zone, of the Washoe County Development Code. Rezoning or reclassification of a lot or parcel from one Regulatory Zone to another requires action by both the Planning Commission and the Board of County Commissioners.

The Planning Commission may deny a Regulatory Zone Amendment or it may recommend approval or modification of an amendment to the Board of County Commissioners. Upon an affirmative recommendation by the Planning Commission, the Board of County Commissioners is required to hold a public hearing which must be noticed pursuant to WCC Section

110.821.20. Final action is taken by the Board of County Commissioners who may adopt, adopt with modifications, or deny the proposed amendment.

This amendment to the South Valleys Regulatory Zone Map is proposing to establish 2.56 acres as General Rural (GR).



Vicinity Map

Background

In 2001 parcel 046-051-49 was acquired by deed by the State of Nevada Department of Transportation (NDOT) as public right-of-way (ROW) for the construction of I-580 in Washoe Valley. However, in early October 2018 NDOT determined that the ROW area was no longer needed and was surplus by deed and the parcel was sold to a private individual (See Exhibit D). Public ROW does not have master plan designation or zoning and Washoe County, as the applicant, is requesting to establish the master plan designation and zoning on the parcel.

Analysis

The request is to establish a master plan designation and a regulatory zone for a ±2.56 acre parcel that is located within the South Valleys Area Plan. The request is for the master plan category of Rural (R) and the regulatory zone of General Rural (GR). There is one single family house and an accessory building, that has been used as a residence and an office for NDOT; these buildings were constructed in 1990's. The main residence is a two-story 2,154 sq. ft. house and the other building is 1,802 sq. ft. in size and there is also, a 208 sq. ft. garage. The parcel is located between I-580 and US Highway 395 in Washoe Valley and NDOT ROW borders the parcel to the north and south. The closest parcel to the north has a master plan designation of Rural (R) and a regulatory zone of General Rural (GR) and the closest parcel to the south has a master plan designation of Commercial (C) and a regulatory zone of General Commercial (GC).

Staff researched the land use and regulatory zone designation of the parcel before the parcel was public ROW and it appears that it was designated Rural (R) and zoned General Rural (GR). Staff determined that it was appropriate to re-establish the previous master plan designation and regulatory zone. Also, most of the surrounding parcels are designated R and the parcel to the north has a regulatory zone of GR. The subject parcel is only ±2.5 acres in size, which does not meet the minimum lot size for the regulatory zone of GR, which is 40 acres; however, the parcel is an existing property with an existing residential use and the proposed master plan land use and regulatory zone is consistent (identical) with the previous land use and regulatory zone. The site is located outside of the Truckee Meadows Service Area (TMSA), which prevents commercial uses from being established. There are parcels in the area zoned GR that have similar characteristics and do not meet the minimum lot size of 40 acres. The buildings on the site are in need of repair and the owner is currently repairing the main residence. The owner has indicated that the building used as a residence and office will be repaired in the future. The proposed master plan and regulatory zone amendments will help support the needed improvements to the property by simplifying the building permit process.

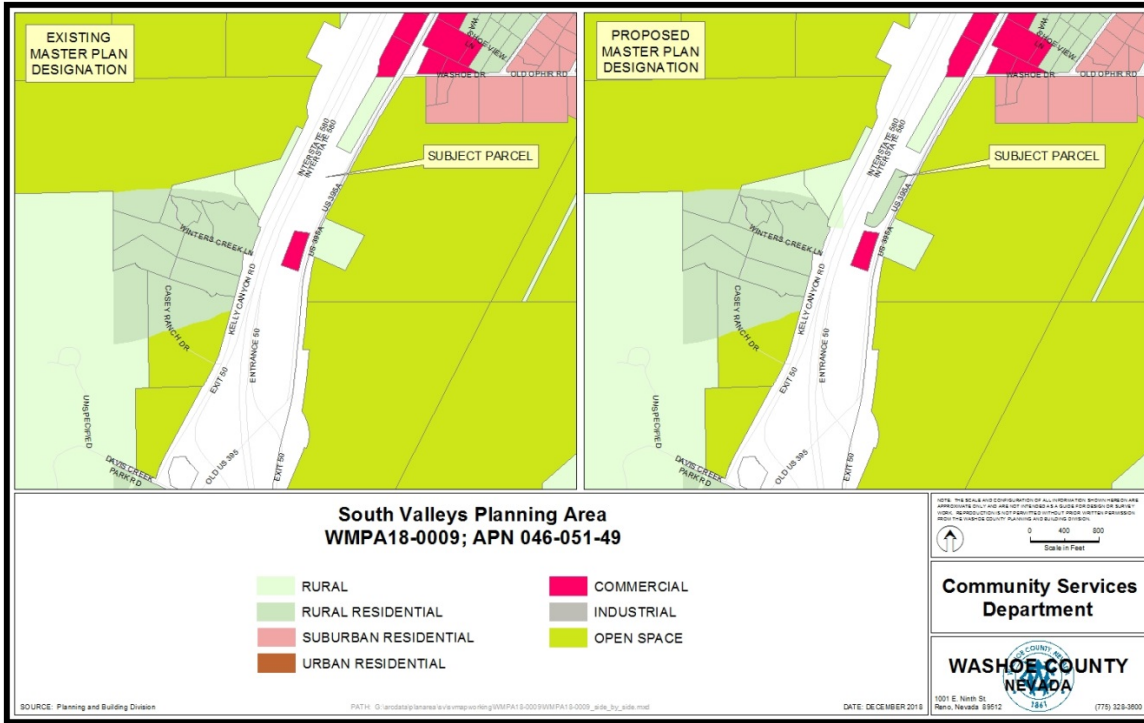

Existing and Proposed Master Plan Designation

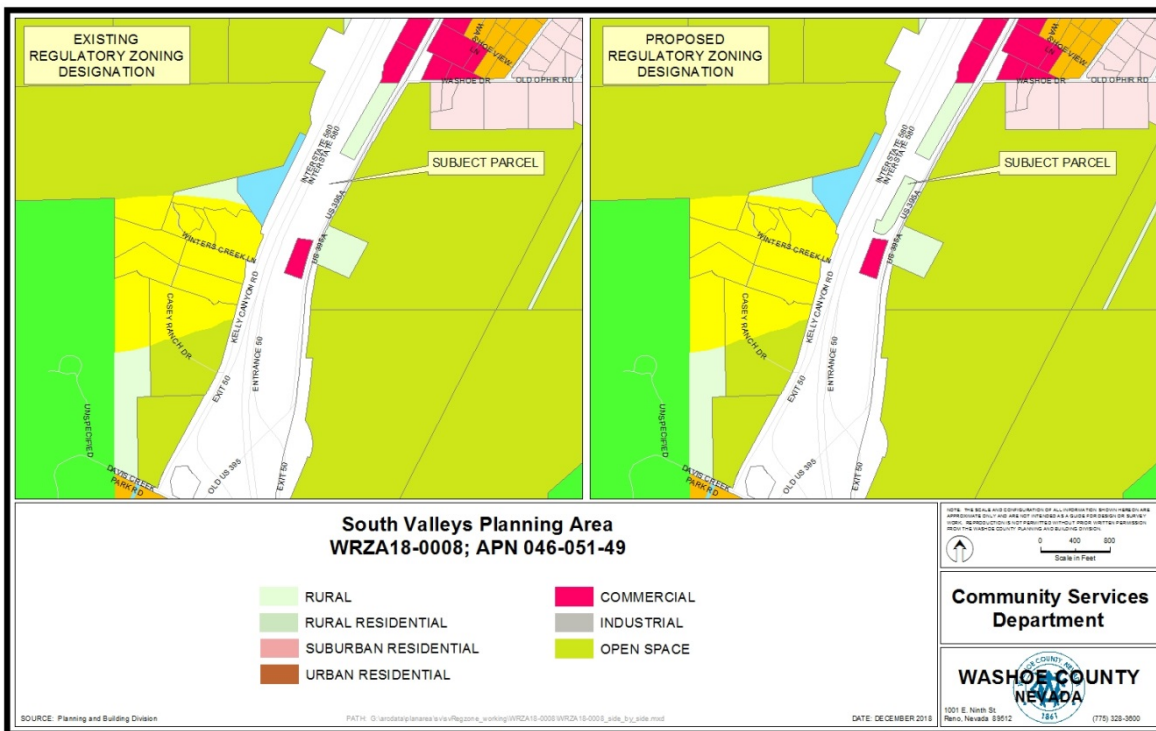

Existing and Proposed Regulatory Zoning

Consistency with Master Plan and Regulatory Zone Map

Master plan amendments and regulatory zone amendments are to be reviewed for consistency with applicable policies and action plans of the Washoe County Master Plan. The following Master Plan policies and programs are applicable to the proposed amendment requests.

South Valleys Area Plan Findings

Master plan amendments are required to be reviewed for compliance with applicable goals and policies of the South Valleys Area Plan, which is a part of the Washoe County Master Plan. The following goals and policies of the South Valleys Area Plan are applicable to the proposed amendment requests.

- SV.1.7 The following Regulatory Zones are permitted within the West Washoe Valley Rural Character Management Area:
- a. **General Rural (GR – One unit per 40 acres).**
 - b. Low Density Rural (LDR – One unit per 10 acres).
 - c. Medium Density Rural (MDR – One unit per 5 acres). (Limited to the areas designated MDR as of the effective date of this plan.)
 - d. Public/Semi-public Facilities (PSP).
 - e. Parks and Recreation (PR).
 - f. Open Space (OS).
 - g. High Density Rural (HDR – One unit per 2.5 acres). (Limited to the areas designated HDR as of the effective date of this plan.)

Staff Comment: The proposed General Rural (GR) is an allowed regulatory zone within the West Washoe Valley Character Management Area.

- SV.29.1 In order for the Washoe County Planning Commission to recommend the approval of an amendment to the South Valleys Area Plan, the following findings must be made:
- a. The amendment will implement the Vision and Character Statement.
 - b. The amendment conforms to all applicable policies of the South Valleys Area Plan for the type of application being considered; the Washoe County Master Plan as amended from time to time; the Regional Water Management Plan as amended from time to time; and the policies of the Truckee Meadows Regional Plan applicable to the amendment under consideration.
 - c. The amendment will not conflict with or diminish the public's health, safety or welfare, including possible effects upon water quality and quantity.

Staff Comment: The proposed change is not in conflict with these findings and will implement the Vision and Character Statement, will meet all of the South Valleys policies and not conflict with or diminish the public's health, safety or welfare, including possible effects upon water quality and quantity.

- SV.29.3 In order for the Washoe County Planning Commission to recommend approval of an amendment involving a change of land use, the following applicable findings must be made, commensurate with a change in regulatory zone per NRS:
- a. At the time of a land use change application submittal, a study shall be submitted, which has been paid for by the applicant, relative to municipal

water, sewer and storm water improvements that clearly identifies the impacts that may accompany such a land use change, and that such needed improvements have been determined to be in substantial compliance with all applicable existing facilities and resource plans for the South Valleys by the Department of Water Resources. For amendments that propose intensified commercial land use, the scale of the intended use has been shown to be consistent with the desired development and vitality of the community, as outlined in the Character Statement and Goal One of the Area Plan.

- b. Washoe County will work to communicate to the providers for transportation, water resources, schools and parks the community's needs as reflected in this plan.
- c. Any existing development in the South Valleys planning area which is subject to the conditions of a discretionary permit shall continue to comply with all applicable conditions of the discretionary permit during the term of the permit and shall be allowed to continue operation of its permitted activities as approved under the discretionary permit process.

Staff Comment: There is no proposed change of land use because the parcel has no master plan designation or regulatory zoning. The application is reestablishing the parcel and the uses that have been on the site and staff does not see a need for any further information or study to be submitted showing that the services are adequate for the site.

Compatible Land Uses

In determining compatibility with surrounding land uses, staff reviewed the Land Use Compatibility Matrix with the proposed regulatory zones. The compatibility matrix is found in the Land Use and Transportation Element in Volume One of the Washoe County Master Plan. The compatibility between the proposed and existing adjacent regulatory zones is captured in the table below:

Compatibility Rating of Proposed Regulatory Zone with Existing Regulatory Zones on Closest Adjacent Parcels

Proposed Regulatory Zone	Existing Regulatory Zones on Closest Adjacent Parcels	Compatibility Rating
General Rural (GR)	General Rural (GR) (located to the north)	High
	Open Space (OS) & General Rural (GR) (located to the east)	High
	General Commercial (GC) (located to the south)	Low
	Public Semi Public Facilities (PSP) (located to the west)	Medium

High Compatibility: Little or no screening or buffering necessary.
Medium Compatibility: Some screening and buffering necessary.
Low Compatibility: Significant screening and buffering necessary.

South Truckee Meadows/ Washoe Valley Citizen Advisory Board (STMWV CAB)

NRS 278.210(2) and WCC Section 110.820.20 require a neighborhood meeting for any proposed master plan amendment. The neighborhood meeting was held at the scheduled STMWV CAB meeting on January 3, 2019 and the CAB members voted unanimously in favor of the request (See Exhibit E to review the CAB minutes).

Public Notice for Master Plan Amendment

Notice for master plan amendments has been provided in accordance with the provisions of Nevada Revised Statutes 278.210, as amended; and Notice for Regulatory Zone amendments has been provided in accordance with the provisions of Nevada Revised Statutes 278.260, as amended. The time and place of the public hearing must be provided in at least one publication or a newspaper of general circulation in the city or county, at least 10 days before the day of the public hearing. NRS requires a minimum of 30 separate property owners be noticed within a 750 foot radius of the subject parcel to which the proposed amendment pertains.

A minimum of 30 property owners within 750 feet of the area to which the proposed amendment pertains must be noticed by mail at least 10 days before the public hearing date. Notice must also be given in a newspaper of general circulation within Washoe County at least 10 days before the public hearing date.

Noticing for this proposal: Thirty-one (31) property owners were noticed by mail not less than 10 days before the public hearing. (See Exhibit F)

Public Notice for Regulatory Zone Amendment

Notice for Regulatory Zone amendments must be given in accordance with the provisions of Nevada Revised Statutes 278.260, as amended, and WCC Section 110.821.20.

Owners of all real property to be noticed are owners identified on the latest County Assessor's ownership maps and records. Such notice is complied with when notice is sent to the last known addresses of such real property owners as identified in the latest County Assessor's records. Any person who attends the public hearing is considered to be legally noticed unless those persons can provide evidence that they were not notified according to the provisions of WCC Section 110.821.20.

Noticing for this proposal: Thirty-one (31) property owners were noticed by mail not less than 10 days before the public hearing. (See Exhibit F)

Agency Comments

The proposed amendment was submitted to the following agencies for review and comment.

- State of Nevada
 - Department of Transportation
- Washoe County Community Services Department
 - Engineering and Capital Projects
 - Traffic
 - Planning and Building
- Washoe County Health District

- Environmental Health Services
- Truckee Meadows Fire Protection District
- Regional Transportation Commission
- Washoe-Storey Conservation District

A comment was received from Washoe County Health District – Environmental Health Services. (See Exhibit D)

Staff Comment on Required Master Plan Amendment Findings

WCC Section 110.820.15(d) requires the Planning Commission to make at least three of the six findings of fact to recommend approval of the amendments to the Washoe County Board of County Commissioners. South Valleys Area Plan Policy 29.1 requires three additional findings to be made. The following findings and staff comments on each finding are presented for the Planning Commission's consideration:

1. **Consistency with Master Plan.** The proposed amendment is in substantial compliance with the policies and action programs of the Master Plan.
Staff Comment: Staff Comment: The proposed amendment does not conflict with the policies and action programs of the Master Plan.
2. **Compatible Land Uses.** The proposed amendment will provide for land uses compatible with (existing or planned) adjacent land uses, and will not adversely impact the public health, safety or welfare.
Staff Comment: The subject site is adjacent to areas that are developed at a similar density to the proposed density.
3. **Response to Change Conditions.** The proposed amendment responds to changed conditions or further studies that have occurred since the plan was adopted by the Board of County Commissioners, and the requested amendment represents a more desirable utilization of land.
Staff Comment: The parcel was part of Nevada State Department of Transportation right-of way and establishing the proposed master plan designation represents the change of ownership of the property to a private individual.
4. **Availability of Facilities.** There are or are planned to be adequate transportation, recreation, utility, and other facilities to accommodate the uses and densities permitted by the proposed Master Plan designation.
Staff Comment: There are existing buildings on the property with a well and septic system and access to US Highway 395 S.
5. **Desired Pattern of Growth.** The proposed amendment will promote the desired pattern for the orderly physical growth of the County and guides development of the County based on the projected population growth with the least amount of natural resource impairment and the efficient expenditure of funds for public services.
Staff Comment: There are existing buildings on the property and no change is proposed to the property.

South Valleys Area Plan Findings

Policy SV.29.1. In order for the Washoe County Planning Commission to recommend the approval of ANY amendment to the South Valleys Area Plan, the following findings must be made:

- a. The amendment will implement the Vision and Character Statement.

Staff Comment: The Character Statement includes, "Provides a limited range of housing opportunities complementary to the area's rural and historic character." The amendment will re-establish a residential use that is complementary to the area.

- b. The amendment conforms to all applicable policies of the South Valleys Area Plan for the type of application being considered; the Washoe County Master Plan as amended from time to time; the Regional Water Management Plan as amended from time to time; and the policies of the Truckee Meadows Regional Plan applicable to the amendment under consideration.

Staff Comment: The amendment complies with the South Valleys Area Plan, the Washoe County Master Plan, the Regional Water Management Plan and the Truckee Meadows Regional Plan policies.

- c. The amendment will not conflict with or diminish the public's health, safety or welfare, including possible effects upon water quality and quantity.

Staff Comment: The proposed change will re-establish the previous master plan designation and regulatory zoning on the parcel.

Policy SV.29.3 In order for the Washoe County Planning Commission to recommend approval of an amendment involving a change of land use, the following applicable findings must be made, commensurate with a change in regulatory zone per NRS:

- a. At the time of a land use change application submittal, a study shall be submitted, which has been paid for by the applicant, relative to municipal water, sewer and storm water improvements that clearly identifies the impacts that may accompany such a land use change, and that such needed improvements have been determined to be in substantial compliance with all applicable existing facilities and resource plans for the South Valleys by the Department of Water Resources. For amendments that propose intensified commercial land use, the scale of the intended use has been shown to be consistent with the desired development and vitality of the community, as outlined in the Character Statement and Goal One of the Area Plan.

Staff Comment: The amendment is reestablishing the previous land use and no intensification is being proposed.

- b. Washoe County will work to communicate to the providers for transportation, water resources, schools and parks the community's needs as reflected in this plan.

Staff Comment: The amendment will not change the community needs on the site.

- c. Any existing development in the South Valleys planning area which is subject to the conditions of a discretionary permit shall continue to comply with all applicable conditions of the discretionary permit during the term of the permit and shall be allowed to continue operation of its permitted activities as approved under the discretionary permit process.

Staff Comment: The amendment is not subject to discretionary permit conditions.

Staff Comment on Required Regulatory Zone Amendment Findings

Washoe County Code Section 110.821.15 requires that all of the following findings be made to the satisfaction of the Washoe County Planning Commission before recommending adoption to the Board of County Commissioners. Staff has completed an analysis of the Regulatory Zone

Amendment application and has determined that the proposal is in compliance with the required findings as follows.

1. Consistency with Master Plan. The proposed amendment is in substantial compliance with the policies and action programs of the Master Plan.

Staff Comment: The proposed amendment does not conflict with the policies and action programs of the Master Plan.

2. Compatible Land Uses. The proposed amendment will provide for land uses compatible with (existing or planned) adjacent land uses, and will not adversely impact the public health, safety or welfare.

Staff Comment: The subject site is adjacent to areas that are developed at a similar density to the proposed density.

3. Response to Change Conditions; more desirable use. The proposed amendment responds to changed conditions or further studies that have occurred since the plan was adopted by the Board of County Commissioners, and the requested amendment represents a more desirable utilization of land.

Staff Comment: The change in the area is the lack of need for this site to remain NDOT ROW and re-establishing the regulatory zoning of GR is appropriate for the site as discussed in the staff report.

4. Availability of Facilities. There are or are planned to be adequate transportation, recreation, utility, and other facilities to accommodate the uses and densities permitted by the proposed amendment.

Staff Comment: There are adequate transportation, recreation, utility, and other facilities for the site.

5. No Adverse Effects. The proposed amendment will not adversely effect the implementation of the policies and action programs of the Washoe County Master Plan.

Staff Comment: The proposed amendment will not impact the implementation of the policies and action programs of the Washoe County Master Plan.

6. Desired Pattern of Growth. The proposed amendment will promote the desired pattern for the orderly physical growth of the County and guides development of the County based on the projected population growth with the least amount of natural resource impairment and the efficient expenditure of funds for public services.

Staff Comment: The proposed amendment will reestablish the land use on the property that was in place before the property was public right-of-way, which promotes the desired pattern of growth in the area.

7. Effect on a Military Installation when a Military Installation is required to be noticed. The proposed amendment will not affect the location, purpose and mission of a military installation.

Staff Comment: There are no military installations within the required noticing area; therefore this finding does not have to be made.

Recommendation

It is recommended that the Washoe County Planning Commission adopt the resolution contained at Exhibit A of this staff report to amend the Master Plan as set forth in Master Plan Amendment Case Number WMPA18-0009. It is further recommended that the Planning

Commission to forward the Master Plan Amendments to the Washoe County Board of County Commissioners for their consideration of adoption. The following motion is provided for your consideration:

Master Plan Amendment Recommended Motions

Initiation

It is recommended that the Washoe County Planning Commission initiate and subsequently recommend approval of the amendment to the Master Plan as set forth in Master Plan Amendment Case Number WMPA18-0009.

Amendment

I move that, after giving reasoned consideration to the information contained in the staff report and information received during the public hearing, the Washoe County Planning Commission adopt the resolution contained at Exhibit A of this staff report to amend the Master Plan as set forth in Master Plan Amendment Case Number WMPA18-0009 having made the following five findings in accordance with Washoe County Code Section 110.820.15(d) and the findings required by South Valleys Area Plan Policy SV.29.1 and SV.29.3. I further move to certify the resolution and the proposed Master Plan Amendments in WMPA18-0009 as set forth in this staff report for submission to the Washoe County Board of County Commissioners and authorize the chair to sign the resolution on behalf of the Planning Commission.

Washoe County Development Code Section 110.820.15(d) Master Plan Amendment Findings

1. Consistency with Master Plan. The proposed amendment is in substantial compliance with the policies and action programs of the Master Plan.
2. Compatible Land Uses. The proposed amendment will provide for land uses compatible with (existing or planned) adjacent land uses, and will not adversely impact the public health, safety or welfare.
3. Response to Change Conditions. The proposed amendment responds to changed conditions or further studies that have occurred since the plan was adopted by the Board of County Commissioners, and the requested amendment represents a more desirable utilization of land.
4. Availability of Facilities. There are or are planned to be adequate transportation, recreation, utility, and other facilities to accommodate the uses and densities permitted by the proposed Master Plan designation.
5. Desired Pattern of Growth. The proposed amendment will promote the desired pattern for the orderly physical growth of the County and guides development of the County based on the projected population growth with the least amount of natural resource impairment and the efficient expenditure of funds for public services.

South Valleys Area Plan Findings - Policy SV.29.1 & SV.29.3 (a part of the Master Plan)

SV.29.1

- a. The amendment will implement the Vision and Character Statement.
- b. The amendment conforms to all applicable policies of the South Valleys Area Plan for the type of application being considered; the Washoe County Master Plan as amended from time to time; the Regional Water Management Plan as

amended from time to time; and the policies of the Truckee Meadows Regional Plan applicable to the amendment under consideration.

- c. The amendment will not conflict with or diminish the public's health, safety or welfare, including possible effects upon water quality and quantity.

SV.29.3

- a. At the time of a land use change application submittal, a study shall be submitted, which has been paid for by the applicant, relative to municipal water, sewer and storm water improvements that clearly identifies the impacts that may accompany such a land use change, and that such needed improvements have been determined to be in substantial compliance with all applicable existing facilities and resource plans for the South Valleys by the Department of Water Resources. For amendments that propose intensified commercial land use, the scale of the intended use has been shown to be consistent with the desired development and vitality of the community, as outlined in the Character Statement and Goal One of the Area Plan.
- b. Washoe County will work to communicate to the providers for transportation, water resources, schools and parks the community's needs as reflected in this plan.
- c. Any existing development in the South Valleys planning area which is subject to the conditions of a discretionary permit shall continue to comply with all applicable conditions of the discretionary permit during the term of the permit and shall be allowed to continue operation of its permitted activities as approved under the discretionary permit process.

Regulatory Zone Amendment Recommended Motions

Initiation

It is recommended that the Washoe County Planning Commission initiate and subsequently recommend approval of the amendment to the South Valleys Regulatory Zone Map set forth in Regulatory Zone Amendment Case Number WRZA18-0008.

Amendment

I move that after giving reasoned consideration to the information contained in the staff report and information received during the public hearing, the Washoe County Planning Commission recommends adoption of the proposed Regulatory Zone Amendment Case Number WRZA18-0008, having made all of the following findings in accordance with Washoe County Code Section 110.821.15(d).

1. Consistency with Master Plan. The proposed amendment is in substantial compliance with the policies and action programs of the Master Plan.
2. Compatible Land Uses. The proposed amendment will provide for land uses compatible with (existing or planned) adjacent land uses, and will not adversely impact the public health, safety or welfare.
3. Response to Change Conditions; more desirable use. The proposed amendment responds to changed conditions or further studies that have occurred since the plan was adopted by the Board of County Commissioners, and the requested amendment represents a more desirable utilization of land.

4. Availability of Facilities. There are or are planned to be adequate transportation, recreation, utility, and other facilities to accommodate the uses and densities permitted by the proposed amendment.
5. No Adverse Effects. The proposed amendment will not adversely affect the implementation of the policies and action programs of the Washoe County Master Plan.
6. Desired Pattern of Growth. The proposed amendment will promote the desired pattern for the orderly physical growth of the County and guides development of the County based on the projected population growth with the least amount of natural resource impairment and the efficient expenditure of funds for public services.
7. Effect on a Military Installation When a Military Installation is Required to be Noticed. The proposed amendment will not affect the location, purpose and mission of the military installation.

Appeal Process

Planning Commission action will be effective 10 calendar days after the written decision is filed with the Secretary to the Planning Commission and mailed to the original applicant, unless the action is appealed to the Washoe County Board of County Commissioners, in which case the outcome of the appeal shall be determined by the Washoe County Board of County Commissioners. Any appeal must be filed in writing with the Planning and Building Division within 10 calendar days from the date the written decision is filed with the Secretary to the Planning Commission and mailed to the original applicant.

Property Owner: Michael D & Penny L Sayan, 1142 S Nevada St. #406, Carson City, NV 98701



RESOLUTION OF THE WASHOE COUNTY PLANNING COMMISSION

INITIATING AND RECOMMENDING APPROVAL OF ADOPTING AMENDMENTS TO THE WASHOE COUNTY MASTER PLAN, SOUTH VALLEYS AREA PLAN, MASTER PLAN MAP (WMPA18-0009), AND RECOMMENDING ITS ADOPTION TO THE BOARD OF COUNTY COMMISSIONERS

Resolution Number 19-08

Whereas, Master Plan Amendment Case Number WMPA18-0009 came before the Washoe County Planning Commission for a duly noticed public hearing on February 5, 2019; and

Whereas, the Washoe County Planning Commission heard public comment and input from both staff and the public regarding the proposed master plan amendments; and

Whereas, the Washoe County Planning Commission gave reasoned consideration to the information it received regarding the proposed master plan amendments;

Whereas, the Washoe County Planning Commission has made the following findings necessary to support initiation and adoption of the proposed Master Plan Amendment Case Number WMPA18-0009, as set forth in NRS chapter 278 and Washoe County Code Chapter 110 (Development Code), Article 820:

Washoe County Code Section 110.820.15 (d) Master Plan Amendment Findings

1. Consistency with Master Plan. The proposed amendment is in substantial compliance with the policies and action programs of the Master Plan.
2. Compatible Land Uses. The proposed amendment will provide for land uses compatible with (existing or planned) adjacent land uses, and will not adversely impact the public health, safety or welfare.
3. Response to Change Conditions. The proposed amendment responds to changed conditions or further studies that have occurred since the plan was adopted by the Board of County Commissioners, and the requested amendment represents a more desirable utilization of land.
4. Availability of Facilities. There are or are planned to be adequate transportation, recreation, utility, and other facilities to accommodate the uses and densities permitted by the proposed Master Plan designation.
5. Desired Pattern of Growth. The proposed amendment will promote the desired pattern for the orderly physical growth of the County and guides development of the County based on the projected population growth with the least amount of natural resource impairment and the efficient expenditure of funds for public services.

South Valleys Area Plan Required Findings

- SV.29.1 In order for the Washoe County Planning Commission to recommend the approval of an amendment to the South Valleys Area Plan, the following findings must be made:
- a. The amendment will implement the Vision and Character Statement.
 - b. The amendment conforms to all applicable policies of the South Valleys Area Plan for the type of application being considered; the Washoe County Master Plan as amended from time to time; the Regional Water Management Plan as amended from time to time; and the policies of the Truckee Meadows Regional Plan applicable to the amendment under consideration.
 - c. The amendment will not conflict with or diminish the public's health, safety or welfare, including possible effects upon water quality and quantity.

SV.29.3

- a. At the time of a land use change application submittal, a study shall be submitted, which has been paid for by the applicant, relative to municipal water, sewer and storm water improvements that clearly identifies the impacts that may accompany such a land use change, and that such needed improvements have been determined to be in substantial compliance with all applicable existing facilities and resource plans for the South Valleys by the Department of Water Resources. For amendments that propose intensified commercial land use, the scale of the intended use has been shown to be consistent with the desired development and vitality of the community, as outlined in the Character Statement and Goal One of the Area Plan.
- b. Washoe County will work to communicate to the providers for transportation, water resources, schools and parks the community's needs as reflected in this plan.
- c. Any existing development in the South Valleys planning area which is subject to the conditions of a discretionary permit shall continue to comply with all applicable conditions of the discretionary permit during the term of the permit and shall be allowed to continue operation of its permitted activities as approved under the discretionary permit process.

Now, therefore, be it resolved that pursuant to NRS 278.210(3):

- (1) Subject to adoption by the Washoe County Board of County Commissioners and a finding of conformance with the Truckee Meadows Regional Plan, the Washoe County Planning Commission does hereby adopt Master Plan Amendment Case Number WMPA18-0009, comprised of the map as included at Exhibit A to this resolution, descriptive matter and other matter intended to constitute the amendments as submitted at the public hearing noted above; and,
- (2) To the extent allowed by law, this approval is subject to the conditions adopted by the Planning Commission at the public hearing noted above.

A certified copy of this resolution shall be submitted to the Washoe County Board of County Commissioners and any appropriate reviewing agencies in accordance with NRS 278.220.

ADOPTED on February 5, 2019

WASHOE COUNTY PLANNING COMMISSION

ATTEST:

Trevor Lloyd, Secretary

Sarah Chvilicek, Chair

Attachment: Exhibit A – South Valley Area Plan Master Plan Map

Exhibit A, WMPA18-0009

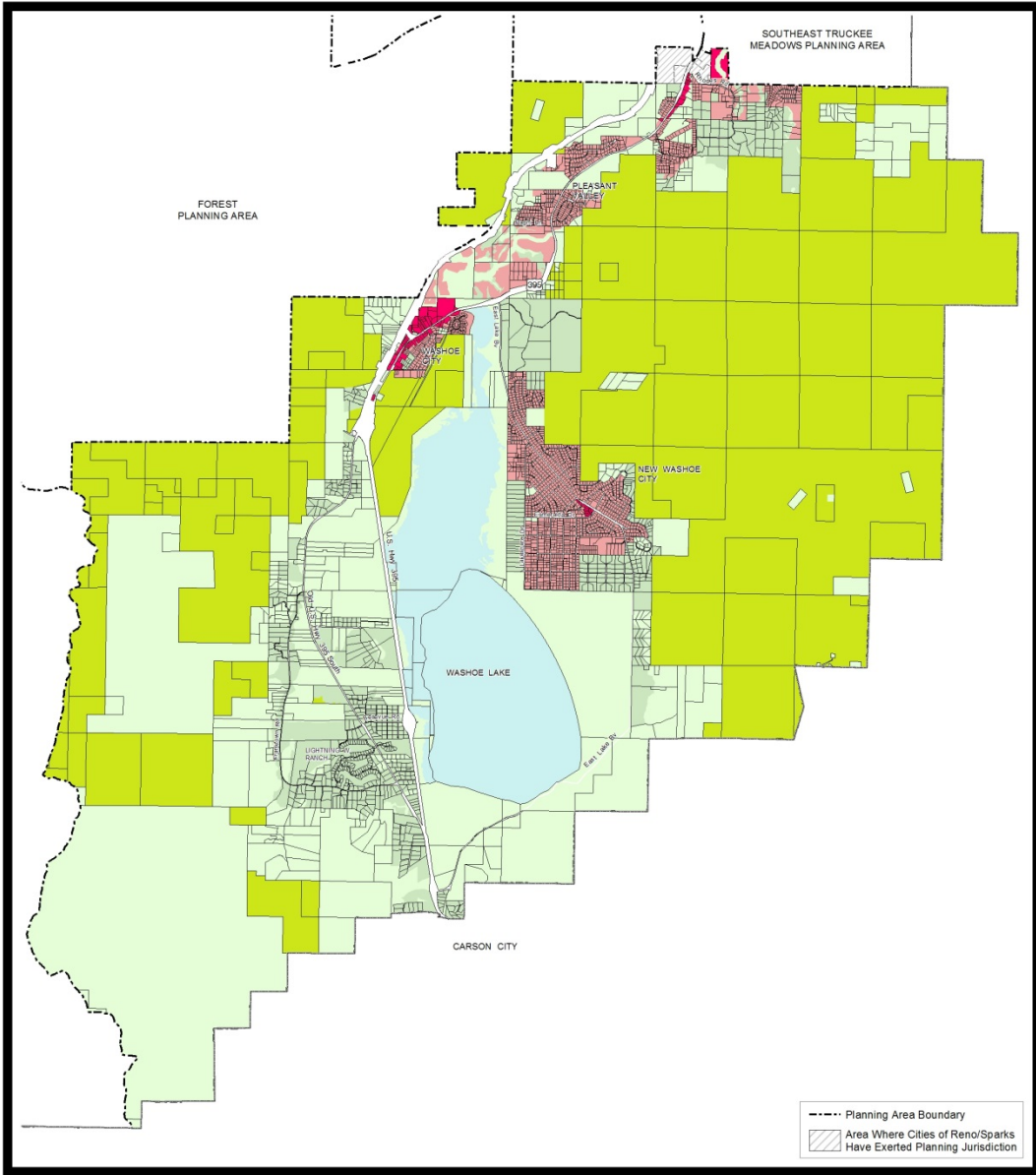

----- Planning Area Boundary
 [Hatched Box] Area Where Cities of Reno/Sparks Have Exerted Planning Jurisdiction

SOUTH VALLEYS MASTER PLAN MAP

- RURAL
- RURAL RESIDENTIAL
- SUBURBAN RESIDENTIAL
- URBAN RESIDENTIAL
- COMMERCIAL
- INDUSTRIAL
- OPEN SPACE

SOURCE: Planning and Building Division

PC Date: February 5, 2019
 BCC Date:
 SPC Conformance Date:
 Resolution Adoption Date:

NOTE: THE SCALE AND CONFIGURATION OF ALL INFORMATION SHOWN HEREON ARE APPROXIMATE ONLY AND ARE NOT INTENDED AS A GUIDE FOR DESIGN OR SURVEY WORK. REPRODUCTION IS NOT PERMITTED WITHOUT PRIOR WRITTEN PERMISSION FROM THE WASHOE COUNTY PLANNING AND BUILDING DIVISION.

CERTIFICATION: THIS DOCUMENT HAS BEEN REVIEWED AND APPROVED AS AN ACCURATE REPRESENTATION OF THE ADOPTED MASTER PLAN MAPS OF WASHOE COUNTY, NEVADA, BY THE WASHOE COUNTY PLANNING AND BUILDING DIVISION.

DATE: _____ DIRECTOR: _____

Community Services Department

WASHOE COUNTY NEVADA

1001 E. Ninth St.
 Reno, Nevada 89512 (775) 328-3600



RESOLUTION OF THE WASHOE COUNTY PLANNING COMMISSION

INITIATING AND RECOMMENDING ADOPTION OF REGULATORY ZONE AMENDMENT CASE NUMBER WRZA18-0008 AND THE AMENDED SOUTH VALLEYS REGULATORY ZONE MAP

Resolution Number 19-07

Whereas Regulatory Zone Amendment Case Number WRZA18-0008 came before the Washoe County Planning Commission for a duly noticed public hearing on February 5, 2019; and

Whereas the Washoe County Planning Commission heard public comment and input from staff regarding the proposed Regulatory Zone Amendment; and

Whereas the Washoe County Planning Commission has given reasoned consideration to the information it has received regarding the proposed Regulatory Zone Amendment; and

Whereas the Washoe County Planning Commission has made the findings necessary to support initiation and adoption of this proposed Regulatory Zone Amendment as set forth in NRS Chapter 278 and Washoe County Code Chapter 110, Article 821, Amendment of Regulatory Zone;

Whereas the proposed Regulatory Zone Amendment shall be recommended for initiation and adoption pending initiation and adoption of the accompanying proposed Master Plan Amendment (WMPA18-0009) by the Washoe County Board of County Commissioners and a finding of conformance by the Truckee Meadows Regional Planning Commission; and

Whereas, pursuant to Washoe County Code Section 110.821.15(d), in making this recommendation, the Washoe County Planning Commission finds this proposed Regulatory Zone Amendment:

1. Consistency with Master Plan. The proposed amendment is in substantial compliance with the policies and action programs of the Master Plan;
2. Compatible Land Uses. The proposed amendment will provide for land uses compatible with (existing or planned) adjacent land uses, and will not adversely impact the public health, safety or welfare;
3. Response to Change Conditions; more desirable use. The proposed amendment responds to changed conditions or further studies that have occurred since the plan was initiated and adopted by the Board of County Commissioners, and the requested amendment represents a more desirable utilization of land;
4. Availability of Facilities. There are or are planned to be adequate transportation, recreation, utility, and other facilities to accommodate the uses and densities permitted by the proposed amendment;

5. No Adverse Effects. The proposed amendment will not adversely effect the implementation of the policies and action programs of the Washoe County Master Plan,
6. Desired Pattern of Growth. The proposed amendment will promote the desired pattern for the orderly physical growth of the County and guides development of the County based on the projected population growth with the least amount of natural resource impairment and the efficient expenditure of funds for public services; and
7. Effect on a Military Installation When a Military Installation is Required to be Noticed. The proposed amendment will not affect the location, purpose and mission of the military installation.

Now, therefore, be it resolved that the Washoe County Planning Commission does hereby recommend adoption of Regulatory Zone Amendment Case Number WRZA18-0008 and the amended South Valleys Area Plan Regulatory Zone Map included as Exhibit A to this resolution to the Washoe County Board of County Commissioners.

ADOPTED on February 5, 2019.

WASHOE COUNTY PLANNING COMMISSION

ATTEST:

Trevor Lloyd, Secretary

Sarah Chvilicek, Chair

Attachment: Exhibit A – South Valleys Area Plan Regulatory Zone Map

Exhibit A, WRZA18-0008

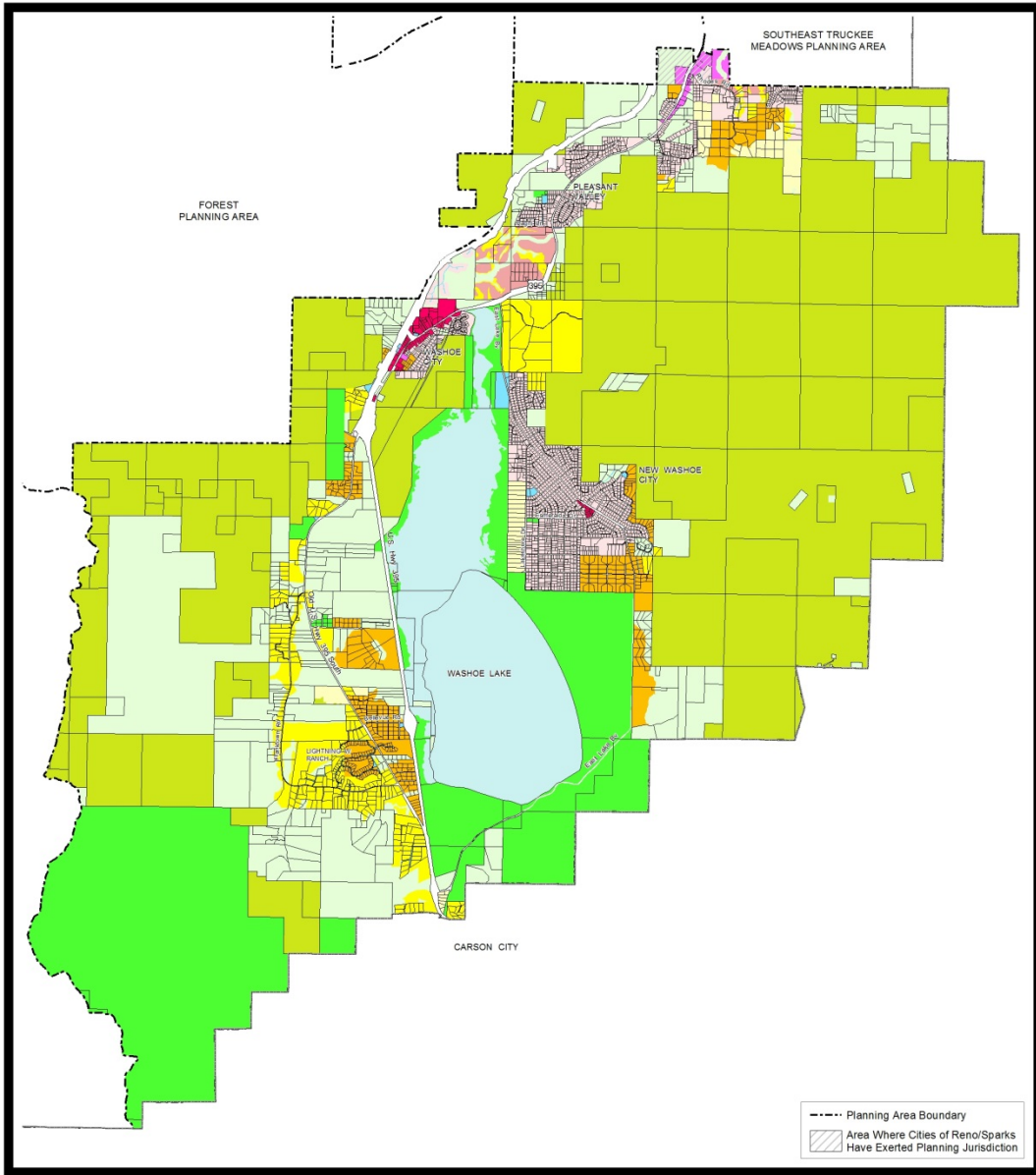

SOUTH VALLEYS REGULATORY ZONE MAP

<ul style="list-style-type: none"> LOW DENSITY RURAL MEDIUM DENSITY RURAL HIGH DENSITY RURAL LOW DENSITY SUBURBAN LOW DENSITY SUBURBAN 2 MEDIUM DENSITY SUBURBAN MEDIUM DENSITY SUBURBAN 4 	<ul style="list-style-type: none"> HIGH DENSITY SUBURBAN LOW DENSITY URBAN MEDIUM DENSITY URBAN HIGH DENSITY URBAN GENERAL COMMERCIAL NEIGHBORHOOD COMMERCIAL/OFFICE TOURIST COMMERCIAL 	<ul style="list-style-type: none"> INDUSTRIAL PUBLIC AND SEMI-PUBLIC FACILITIES PARKS AND RECREATION OPEN SPACE GENERAL RURAL GENERAL RURAL RESIDENTIAL DRY LAKE/WATER BODY
--	---	---

SOURCE: Planning and Building Division

NOTE: THE SCALE AND CONFIGURATION OF ALL INFORMATION SHOWN HEREON ARE APPROXIMATE ONLY AND ARE NOT INTENDED AS A GUIDE FOR DESIGN OR SURVEY WORK. REPRODUCTION IS NOT PERMITTED WITHOUT PRIOR WRITTEN PERMISSION FROM THE WASHOE COUNTY PLANNING AND BUILDING DIVISION.

© Washoe County, NV 2019
wplanning_building@washoe-nv.gov

0 2000 4000 8000
Feet

CERTIFICATION:
THIS DOCUMENT HAS BEEN REVIEWED AND APPROVED AS AN ACCURATE REPRESENTATION OF THE ADOPTED ZONING MAPS OF WASHOE COUNTY, NEVADA, BY THE WASHOE COUNTY PLANNING AND BUILDING DIVISION.

DATE: _____ DIRECTOR: _____

**Community Services
Department**

**WASHOE COUNTY
NEVADA**

1001 E. Ninth St.
Reno, Nevada 89512 (775) 328-3600

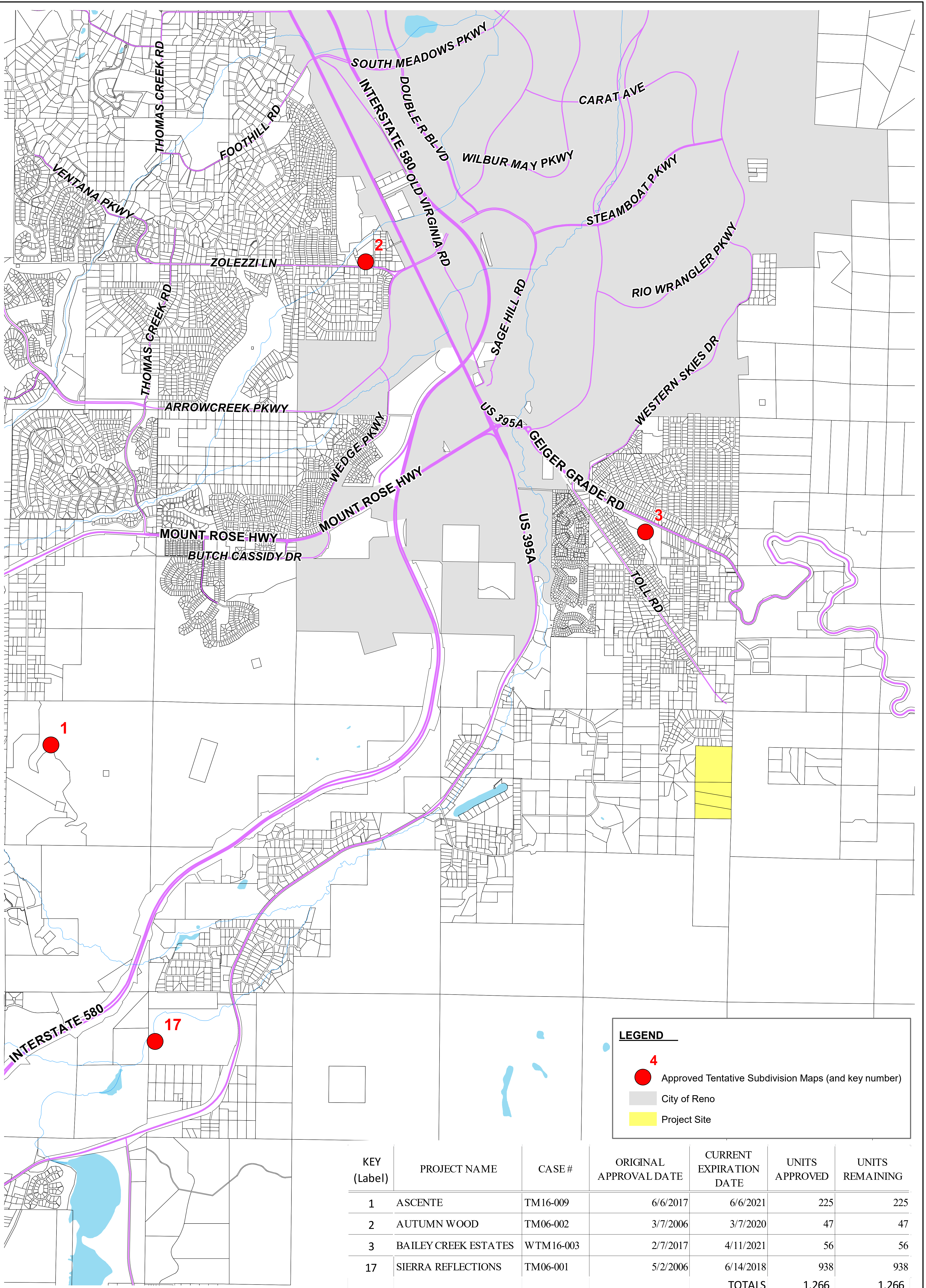

SOURCE: Community Services Department, Planning and Development Division

KEY (Label)	PROJECT NAME	CASE #	ORIGINAL APPROVAL DATE	CURRENT EXPIRATION DATE	UNITS APPROVED	UNITS REMAINING
1	ASCENTE	TM16-009	6/6/2017	6/6/2021	225	225
2	AUTUMN WOOD	TM06-002	3/7/2006	3/7/2020	47	47
3	BAILEY CREEK ESTATES	WTM16-003	2/7/2017	4/11/2021	56	56
17	SIERRA REFLECTIONS	TM06-001	5/2/2006	6/14/2018	938	938
TOTALS					1,266	1,266

**Planning and Development
Community Services Department**

G:\arcdata\projects\approve_unb\SETM_App_unbuilt_Dec2016.mxd

**Approved Residential Subdivisions
TOLL ROAD VICINITY**

**WASHOE COUNTY
NEVADA**

Post Office Box 11130
Reno, Nevada 89520

December, 2016
(775) 328-3600

890

Adj. to APN:046-051-25
Projects: QF-395-2(17)
EB-STP-NH-395-2(017)

E.A.: 71323

Parcel: U-395-WA-007.758XS1

Surplus No.: SUR 16-11



AFTER RECORDING RETURN TO:
NEVADA DEPT. OF TRANSPORTATION
RIGHT-OF-WAY DIVISION
ATTN: STAFF SPECIALIST, PM
1263 S. STEWART ST.
CARSON CITY, NV. 89712

MAIL TAX STATEMENTS TO:
MICHAEL DENNIS & PENNY SAYAN
1142 S NEVADA STREET # 406
CARSON CITY, NV 89701

LEGAL DESCRIPTION PREPARED BY:
JEFF HENKELMAN
NEVADA DEPT. OF TRANSPORTATION
RIGHT-OF-WAY DIVISION
1263 S. STEWART ST.
CARSON CITY, NV. 89712

QUITCLAIM DEED

THIS DEED, made this 19th day of September, 2018,
between the STATE OF NEVADA, acting by and through its Department of Transportation,
hereinafter called "GRANTOR", and MICHAEL DENNIS SAYAN AND PENNY LYNN
SAYAN, as joint tenants with right of survivorship, hereinafter called "GRANTEE",

WITNESSETH:

That said GRANTOR, for and in consideration of the sum of ONE DOLLAR (\$1.00),
lawful money of the United States of America and other good and valuable consideration,
the receipt whereof is hereby acknowledged, and acting in accordance with the provisions
of Chapter 408 of the Nevada Revised Statutes, does hereby remise, release and forever
quitclaim unto the said GRANTEE all of the right, title and fee interest of said GRANTOR
in and to that certain real property situate, lying and being in the County of Washoe, State
of Nevada and more particularly described as being a portion of the W 1/2 of the NW 1/4
of Section 26, T. 17 N., R. 19 E., M.D.M., and further described as being a portion of
Parcel 2 as shown on that certain PARCEL MAP for MICHAEL D. and PEGGY L. SAYAN
and MYRON G. SAYAN filed for record on September 10, 1987, in the Official Records of
Washoe County, Nevada, as File No. 1191340, and more fully described by metes and
bounds as follows:

BEGINNING at a point on the left or northwesterly right-of-way line of US-395A and the right or southeasterly right-of-way line of IR-580, 80.00 feet left of and measured radially to the centerline of US-395A at Highway Engineer's Station "Ge" 50+92.86 P.O.C.; said point of beginning being further described as bearing S. 45°25'27" W. a distance of 2,280.48 feet from a GLO brass cap stamped "S23/26, T17N R19E", shown and delineated as "FD. BRASS CAP" on that certain FIRST PARCEL MAP FOR ALBERT W. DYER, ETAL filed for record on May 15, 1996, in the Official Records of Washoe County, Nevada, as File No. 1994771; thence along said right-of-way line of IR-580 the following eight (8) courses and distances:

- 1) S. 38°21'14" W. – 67.15 feet;
- 2) S. 45°45'51" W. – 72.21 feet;
- 3) from a tangent which bears the last described course, curving to the right with a radius of 75.00 feet, through an angle of 72°07'29", an arc distance of 94.41 feet;
- 4) N. 62°06'40" W. – 69.31 feet;
- 5) N. 15°17'01" E. – 137.63 feet;
- 6) S. 74°53'58" E. – 53.41 feet;
- 7) N. 28°44'07" E. – 586.72 feet;
- 8) S. 65°32'00" E. – 150.64 feet to said northwesterly right-of-way line of US-395A;

thence S. 28°53'59" W., along said right-of-way line of US-395A, a distance of 405.63 feet; thence from a tangent which bears the last described course, curving to the left continuing along said right-of-way line of US-395A, with a radius of 2,980.00 feet, through an angle of 2°52'28", an arc distance of 149.50 feet to the point of beginning; said parcel contains an area of 2.56 acres (111,524 square feet).

SUBJECT TO any and all existing utilities, whether of record or not.

The above described parcel is delineated and identified as Parcel U-395-WA-007.758 XS1, on EXHIBIT "A" and EXHIBIT "B", attached hereto and made a part hereof.

RESERVING unto the GRANTOR a permanent easement for access over and across the above described parcel. Said permanent easement is further described by metes and bounds as follows:

BEGINNING at a point on the left or northwesterly right-of-way line of US-395A and the right or southeasterly right-of-way line of IR-580, 80.00 feet left of and measured radially to the centerline of US-395A at Highway Engineer's Station "Ge" 50+92.86 P.O.C.; thence along said right-of-way line of IR-580 the following five (5) courses and distances:

- 1) S. 38°21'14" W. – 67.15 feet;
- 2) S. 45°45'51" W. – 72.21 feet;
- 3) from a tangent which bears the last described course, curving to the right with a radius of 75.00 feet, through an angle of 72°07'29", an arc distance of 94.41 feet;
- 4) N. 62°06'40" W. – 69.31 feet;
- 5) N. 15°17'01" E. – 12.30 feet;

thence the following eight (8) courses and distances:

- 1) S. 62°06'40" E. – 71.99 feet;
- 2) from a tangent which bears the last described course, curving to the left with a radius of 60.00 feet, through an angle of 68°49'05", an arc distance of 72.07 feet;
- 3) N. 49°04'16" E. – 44.52 feet;
- 4) N. 39°37'17" E. – 69.01 feet;
- 5) N. 29°50'52" E. – 71.07 feet;
- 6) N. 17°46'20" E. – 35.55 feet;
- 7) N. 23°10'17" E. – 60.74 feet;
- 8) N. 29°12'08" E. – 414.44 feet to the northeasterly right-of-way line of said IR-580;

thence S. 65°32'00" E., along said northeasterly right-of-way line, a distance of 25.08 feet to said northwesterly right-of-way line of US-395A; thence S. 28°53'59" W., along said right-of-way line of US-395A, a distance of 405.63 feet; thence from a tangent which bears the last described course, curving to the left continuing along said right-of-way line of US-395A, with a radius of 2,980.00 feet, through an angle of 2°52'28", an arc distance of 149.50 feet to the point of beginning; said permanent easement contains an area of 17,639 square feet (0.40 acres).

The Basis of Bearing for this description is the NEVADA STATE PLANE COORDINATE SYSTEM, NAD 83/94 DATUM, West Zone as determined by the State of Nevada, Department of Transportation.

IN WITNESS WHEREOF, the said GRANTOR has caused these presents to be executed and its seal to be hereunto affixed the day and year first above written.

S
T
A
T
E

S
E
A
L

STATE OF NEVADA, acting by and through its DEPARTMENT OF TRANSPORTATION

Cole Mortensen
Cole Mortensen *for* Director

REVIEWED AND RECOMMENDED BY:

N/A
, District Engineer

Ruth Borrelli
Ruth Borrelli, Chief Right-of-Way Agent

APPROVED FOR LEGALITY AND FORM:

Louis F. Holland 9-17-2018
Louis F. Holland Deputy Attorney General

STATE OF NEVADA
CARSON CITY

On this 19th day of September, 2018,
personally appeared before me, the undersigned, a Notary Public in and for Carson City, State of Nevada, Cole Mortensen
 personally known (or proved) to me to be the Assistant Director of the Department of Transportation of the State of Nevada who subscribed to the above instrument for the Nevada Department of Transportation under authorization of Nevada Revised Statutes, 408.205; that he affirms that the seal affixed to said instrument is the seal of said Department; and that said instrument was executed for the Nevada Department of Transportation freely and voluntarily and for the uses and purposes therein mentioned.

S
E
A
L

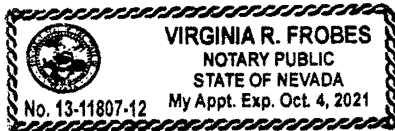

IN WITNESS WHEREOF I have hereunto set my hand and affixed my official seal the day and year in this certificate first above written.

[Signature]

D18-103

PARCEL NO. PREFIX: U-395-WA- EXHIBIT "A"

PROJECTS: QF-395-2(17)
 EB-STP-NH-395-2(017)
 E.A.: 71323

COUNTY OF WASHOE

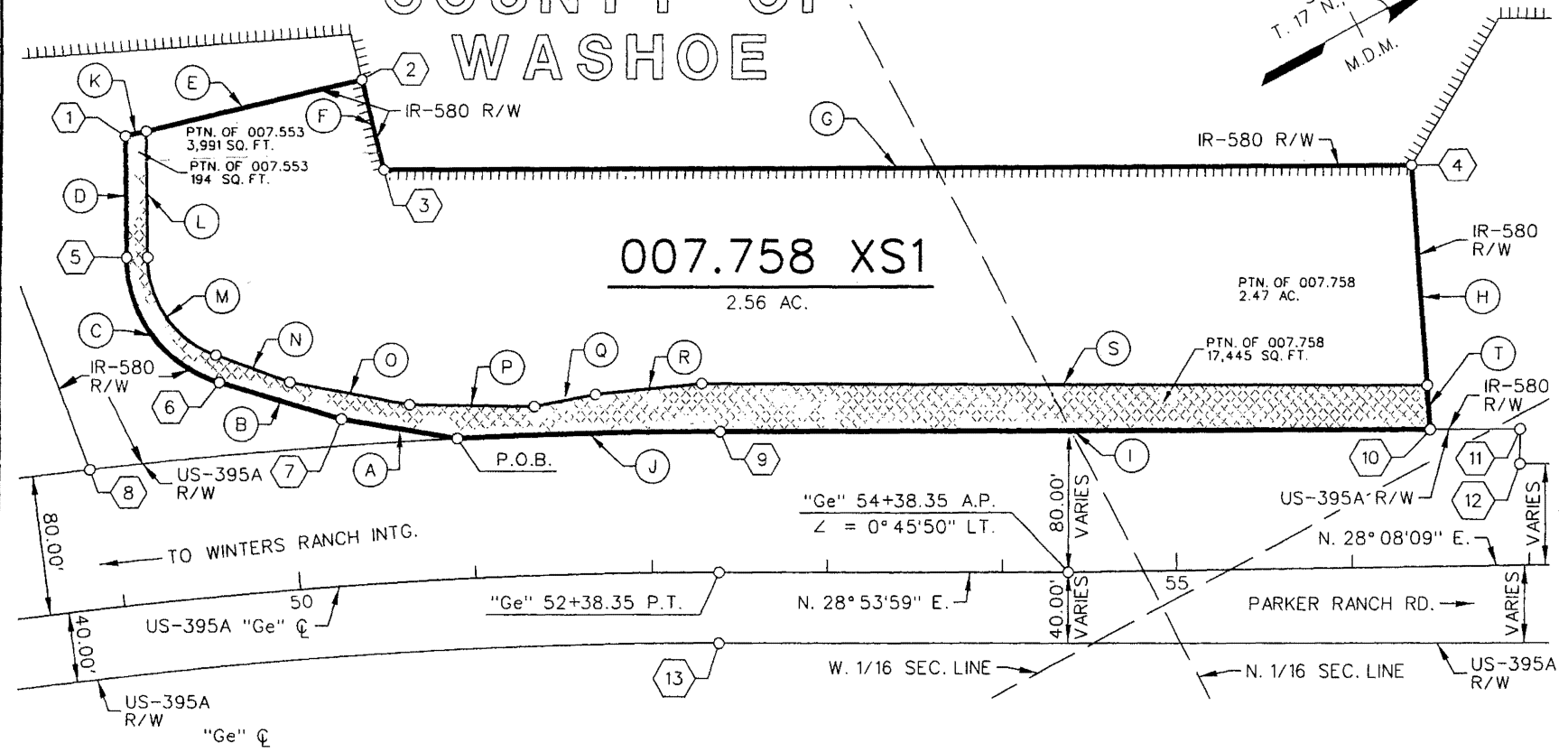

"Ge" ϕ
 $\Delta = 22^\circ 59' 30''$
 $R = 2,900.00'$
 $L = 1,163.72'$

- AREA TO BE QUITCLAIMED
- 17,639 SQ. FT. PERMANENT EASEMENT TO BE RESERVED TO NDOT

SUR 16-11 STATE OF NEVADA WA-04
 DEPARTMENT OF TRANSPORTATION

DATE: MAY 1, 2018

SKETCH MAP

APPROVED: *[Signature]*
 MANAGER II, R/W SURVEY SERVICES

SCALE 1" = 100' SHEET 1 OF 2

NEVADA DOT	TRACED	AKR
	CHECKED	<i>[Signature]</i>
	DATE OF LAST REVISION:	

MAP ID NO.: 56349
 \Divisions\037_RightOfWay\SURPLUS\SUR_16-11.dgn

4855198 Page 5 of 7 - 10/01/2018 12:57:13 PM

PARCEL NO. PREFIX: U-395-WA- EXHIBIT "B" PROJECTS: QF-395-2(17)
 EB-STP-NH-395-2(017)
 E.A.: 71323

PERMANENT EASEMENT

P.O.B. = 80.00' LT. "Ge" 50+92.86 P.O.C.
 TIE: S. 45° 25' 27" W. - 2,280.48' FROM THE
 N 1/4 COR. SEC. 26, T. 17 N., R. 19 E., M.D.M.

(A)	S. 38° 21' 14" W. - 67.15'
(B)	S. 45° 45' 51" W. - 72.21'
(C)	Δ = 72° 07' 29" R = 75.00' L = 94.41'
(D)	N. 62° 06' 40" W. - 69.31'
(K)	N. 15° 17' 01" E. - 12.30'
(L)	S. 62° 06' 40" E. - 71.99'
(M)	Δ = 68° 49' 05" R = 60.00' L = 72.07'
(N)	N. 49° 04' 16" E. - 44.52'
(O)	N. 39° 37' 17" E. - 69.01'
(P)	N. 29° 50' 52" E. - 71.07'
(Q)	N. 17° 46' 20" E. - 35.55'
(R)	N. 23° 10' 17" E. - 60.74'
(S)	N. 29° 12' 08" E. - 414.44'
(T)	S. 65° 32' 00" E. - 25.08'
(I)	S. 28° 53' 59" W. - 405.63'
(J)	Δ = 2° 52' 28" R = 2,980.00' L = 149.50'

007.758 XS1

P.O.B. = 80.00' LT. "Ge" 50+92.86 P.O.C.
 TIE: S. 45° 25' 27" W. - 2,280.48' FROM THE
 N 1/4 COR. SEC. 26, T. 17 N., R. 19 E., M.D.M.

(A)	S. 38° 21' 14" W. - 67.15'
(B)	S. 45° 45' 51" W. - 72.21'
(C)	Δ = 72° 07' 29" R = 75.00' L = 94.41'
(D)	N. 62° 06' 40" W. - 69.31'
(E)	N. 15° 17' 01" E. - 137.63'
(F)	S. 74° 53' 58" E. - 53.41'
(G)	N. 28° 44' 07" E. - 586.72'
(H)	S. 65° 32' 00" E. - 150.64'
(I)	S. 28° 53' 59" W. - 405.63'
(J)	Δ = 2° 52' 28" R = 2,980.00' L = 149.50'

ROW OFFSETS

(1)	266.21' LT. "Ge" 49+27.03 P.O.C.
(2)	287.01' LT. "Ge" 50+51.25 P.O.C.
(3)	234.44' LT. "Ge" 50+59.91 P.O.C.
(4)	227.59' LT. "Ge" 56+35.38 P.O.T.
(5)	197.18' LT. "Ge" 49+21.22 P.O.C.
(6)	121.68' LT. "Ge" 49+64.62 P.O.C.
(7)	95.06' LT. "Ge" 50+29.33 P.O.C.
(8)	80.00' LT. "Ge" 48+88.78 P.O.C.
(9)	80.00' LT. "Ge" 52+38.35 P.T.
(10)	77.25' LT. "Ge" 56+45.02 P.O.T.
(11)	76.58' LT. "Ge" 56+95.58 P.O.T.
(12)	56.58' LT. "Ge" 56+95.31 P.O.T.
(13)	40.00' RT. "Ge" 52+38.35 P.T.

4855198 Page 6 of 7 - 10/01/2018 12:57:13 PM

MAP ID NO.: 56349
 \Divisions\037_RightOfWay\SURPLUS\SUR_16-11.dgn

	TRACED	AKR
	CHECKED	<i>[Signature]</i>
	DATE OF LAST REVISION:	

SUR 16-11 STATE OF NEVADA WA-04
 DEPARTMENT OF TRANSPORTATION

DATE: MAY 1, 2018

SKETCH MAP

APPROVED: *[Signature]*
 MANAGER II, R/W SURVEY SERVICES

SCALE 1" = 100' SHEET 2 OF 2



WASHOE COUNTY RECORDER

OFFICE OF THE COUNTY RECORDER
LAWRENCE R. BURTNES, RECORDER

1001 E. NINTH STREET
POST OFFICE BOX 11130
RENO, NEVADA 89520-0027
PHONE (775) 328-3661
FAX (775) 325-8010

LEGIBILITY NOTICE

The Washoe County Recorder's Office has determined that the attached document may not be suitable for recording by the method used by the Recorder to preserve the Recorder's records. The customer was advised that copies reproduced from the recorded document would not be legible. However, the customer demanded that the document be recorded without delay as the parties rights may be adversely affected because of a delay in recording. Therefore, pursuant to NRS 247.120 (3), the County Recorder accepted the document conditionally, based on the undersigned's representation (1) that a suitable copy will be submitted at a later date (2) it is impossible or impracticable to submit a more suitable copy.

By my signing below, I acknowledge that I have been advised that once the document has been microfilmed it may not reproduce a legible copy.

Signature

10-1-18
Date

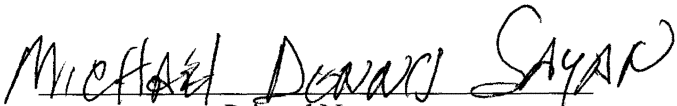
Printed Name

DECLARATION OF VALUE

Instrument # _____

Full Value of Property Interest Conveyed \$ _____

Less Assumed Liens & Encumbrances - _____

Taxable Value (NRS 375.010) \$ _____

Real Property Transfer Tax Due \$ 0 _____

2168626

If exempt, state reason, NRS 375.090, Section #2 Explain:

Transfer to State of Nevada Dept of Transportation

BK5095PG0815

INDIVIDUAL

Under penalty of perjury, I hereby declare that the above statements are correct.

Signature of Declarant

Name (Please Print)

Address

City

State

Zip

ESCROW HOLDER

Under penalty of perjury, I hereby declare that the above statements are correct to the best of my knowledge based upon the information available to me in the documents contained in the escrow file.

Luan Hoyer

Signature of Declarant

Luan Hoyer

Name (Please Print)

187403 LH

Escrow Number

1st American Title

Firm Name

100 S Meadows Hwy #400

Address

Low N 89511

City

State

Zip

AP 11 - 0

2168626

Escrow No. 187403LH

Project: SPSR-430(7)
E.A. 72207
Parcel: S-430-WA-000.818
Underlying Fee

1263 S. Stewart St.
Carson City, Nevada 89712
Ptn. of S.R. 430 (Carson-Reno Highway)
APN 46 051 23

QUITCLAIM DEED

THIS DEED, made this 23rd day of December, 19 97, between DENNIS and PENNY SAYAN, husband and wife, as to an undivided one-half interest and DENNIS SAYAN AND PENNY SAYAN, husband and wife, as Joint Tenants, as to an undivided one-half interest, hereinafter called GRANTOR, and the STATE OF NEVADA, acting by and through its Department of Transportation, hereinafter called GRANTEE,

WITNESSETH:

That the GRANTOR, for and in consideration of the sum of ONE DOLLAR (\$1.00) lawful money of the United States of America and other good and valuable consideration, the receipt whereof is hereby acknowledged, does hereby remise, release and forever quitclaim unto the GRANTEE and to its assigns forever, for those purposes as contained in Chapter 408 of the Nevada Revised Statutes, all of GRANTOR'S right, title and interest in and to that certain real property; said real property situate, lying and being in the County of Washoe, State of Nevada, and more particularly described as being a portion of the NW 1/4 of Section 26, the SE 1/4 of the SW 1/4 and the W 1/2 of the SE 1/4 and the NE 1/4 of the SE 1/4 and the SE 1/4 of the NE 1/4 of Section 23, T. 17 N., R. 19 E., M.D.M.; being a parcel or strip of land varying in width, varying on each side of the surveyed highway centerline of S.R. 430 (Carson-Reno Highway) between Highway Engineer's Stations "G3" 41+92.49 P.O.C. and "G" 113+45.51 P.O.T., which centerline is more fully described as follows, to wit:

BEGINNING at Highway Engineer's Station "G3" 41+92.49 P.O.C. on the centerline of S.R. 430 (Carson-Reno Highway); said point of beginning further described as bearing S. 38°38'32" W. a distance of 2,874.75 feet (876.226 meters) from the north quarter corner of Section 26, T. 17 N., R. 19 E., M.D.M.; thence along said centerline the following eight (8) courses and distances:

- 1) from a tangent which bears N. 13°54'18" E., curving to the right with a radius of 3,600 feet (1097.282

BK 5095PG0816

BK5095P60817

meters), through an angle of 17°41'17", an arc distance of 1,111.37 feet (338.746 meters);

- 2) N. 31°35'35" E. - 1,217.86 feet (371.204 meters);
- 3) from a tangent which bears the last described course, curving to the left with a radius of 15,000 feet (4572.009 meters), through an angle of 1°44'36", an arc distance of 456.40 feet (139.111 meters);
- 4) N. 29°50'59" E. - 1,567.84 feet (477.878 meters);
- 5) from a tangent which bears the last described course, curving to the right with a radius of 2,000 feet (609.601 meters), through an angle of 26°55'29", an arc distance of 939.85 feet (286.467 meters);
- 6) N. 56°46'28" E. - 806.51 feet (245.825 meters) to Highway Engineer's Station "G2" 103+00.00 ∠;
- 7) N. 56°17'49" E. - 720.00 feet (219.456 meters) to Highway Engineer's Station Equation "G2" 110+20.00 ∠ = "G" 110+20.00 P.O.T.;
- 8) N. 56°46'28" E. - 325.51 feet (99.216 meters) to Highway Engineer's Station "G" 113+45.51 P.O.T., the point of ending;

said point of ending further described as bearing N. 20°12'50" W. a distance of 700.97 feet (213.656 meters) from the east quarter corner of Section 23, T. 17 N., R. 19 E., M.D.M.

It is the intent of this instrument to convey and quitclaim any and all interest the GRANTOR may have in and to S.R. 430 (Carson-Reno Highway).

TOGETHER with all and singular the tenements, hereditaments and appurtenances thereunto belonging, or in anywise appertaining, and the reversion and reversions, remainder and remainders, rents, issues and profits thereof; with the exception of any and all reservations as are previously hereinabove expressly excepted from this conveyance.

TO HAVE AND TO HOLD all and singular the said real property, together with the appurtenances, unto the said GRANTEE and to any heirs, successors and assigns forever.

...
...
...

IN WITNESS WHEREOF said GRANTOR has hereunto signed on the day and year first above written.

DENNIS SAYAN

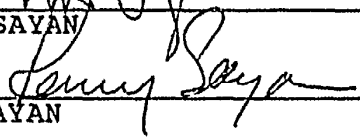
PENNY SAYAN

STATE OF NEVADA)
) ss.
COUNTY OF Washoe)

On this 23 day of December, 19 97,
personally appeared before me, the undersigned, a Notary Public
in and for the County of Washoe, State of Nevada,

Dennis Sayan + Penny Sayan
personally known (or proved) to me to
be the person s whose name is subscribed to the above instrument
and who acknowledged to me that he y executed the same freely
and voluntarily and for the uses and purposes thereby mentioned.

S
E
A
L

IN WITNESS WHEREOF I have hereunto set
my hand and affixed my official seal
the day and year in this certificate
first above written.

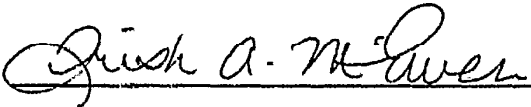
TRISH A. McEwen



BK5095PG0818

2168626

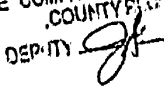
2:00 pm
JAN 07 1998
OFFICIAL RECORDS, WASHOE COUNTY, NEVADA
Record Requested by
FIRST AMERICAN TITLE COMPANY OF NEVADA
COUNTY RECORDER
FEE 0 DEPUTY 

DECLARATION OF VALUE

Instrument # _____

Full Value of Property Interest Conveyed \$ _____
 Less Assumed Liens & Encumbrances - _____
 Taxable Value (NRS 375.010) \$ _____
 Real Property Transfer Tax Due \$ 0

2168627

If exempt, state reason. NRS 375.090, Section #2 Explain:

Transfer To State of Nevada - Dept of Transportation

BK5095PG0819

INDIVIDUAL

Under penalty of perjury, I hereby declare that the above statements are correct.

Signature of Declarant

Name (Please Print)

Address

City State Zip

ESCROW HOLDER

Under penalty of perjury, I hereby declare that the above statements are correct to the best of my knowledge based upon the information available to me in the documents contained in the escrow file.

Luann Hofer

Signature of Declarant

Luann Hofer

Name (Please Print)

187403 LH

Escrow Number

1st American Title

Firm Name

800 S. Mendenhall Pkwy #400

Address

Las Vegas NV 89101

City State Zip

2168627

RPT - 0

Escrow No. 187403LH
1263 S. Stewart St.
Carson City, Nevada 89712
All of APN 46-051-23

Project: QF-395-2(17)
E.A. 71323
Parcel: U-395-WA-007.758

DEED

THIS DEED, made this 23rd day of December, 1997, between DENNIS and PENNY SAYAN, husband and wife, as to an undivided one-half interest and DENNIS SAYAN AND PENNY SAYAN, husband and wife, as Joint Tenants, as to an undivided one-half interest, hereinafter called GRANTOR, and the STATE OF NEVADA, acting by and through its Department of Transportation, hereinafter called GRANTEE,

WITNESSETH:

That the GRANTOR, for and in consideration of the sum of ONE DOLLAR (\$1.00), lawful money of the United States of America, and other good and valuable consideration, the receipt whereof is hereby acknowledged, does by these presents grant, bargain, and sell unto the GRANTEE and to its assigns forever, for those purposes as contained in Chapter 408 of the Nevada Revised Statutes, all that certain real property of GRANTOR, said real property situate, lying and being in the County of Washoe, State of Nevada, and more particularly described as being a portion of the SW 1/4 of the NW 1/4, and the N 1/2 of the NW 1/4 of Section 26, T. 17 N., R. 19 E., M.D.M., and further described as being a portion of PARCEL 2, shown on PARCEL MAP for MICHAEL D. and PEGGY L. SAYAN and MYRON G. SAYAN, FILE NO. 1191340, according to the map filed on September 10, 1987, Official Records of Washoe County, Nevada, as Parcel Map No. 2186, and more fully described by metes and bounds as follows, to wit:

BEGINNING at a point on the right or easterly right-of-way line of U.S. 395 Freeway and the southerly boundary line of PARCEL 2 shown on that certain PARCEL MAP for MICHAEL D. and PEGGY L. SAYAN and MYRON G. SAYAN, FILE NO. 1191340, filed for record on September 10, 1987, Official Records of Washoe County, Nevada, as Parcel Map No. 2186, 96.00 feet right of and measured radially from Highway Engineer's Station "SN" 55+69.90 P.O.C.; said point of beginning further described as bearing S. 46°55'04" W. a distance of 2,586.22 feet from the north quarter corner of Section 26, T. 17 N., R. 19 E., M.D.M.; thence from a tangent which bears N. 24°48'37" E., curving to the right along the former easterly right-of-way line of said U.S. 395 Freeway, with a radius of 4,850 feet, through an angle of 2°37'01", an arc distance of 221.52 feet to a point; thence N. 27°25'38" E., along said former easterly right-of-way line, a distance of 879.08 feet to a point

BK5095PG0820

on the northerly boundary line of said PARCEL 2; thence S. 62°06'19" E., along said northerly boundary line of PARCEL 2, a distance of 201.05 feet to the northeast corner of said PARCEL 2, the last 172.05 feet being coincident with said easterly right-of-way line of U.S. 395 Freeway; thence S. 28°53'58" W., along the easterly boundary line of said PARCEL 2, which is coincident with said easterly right-of-way line, a distance of 224.70 feet to a point on the left or westerly right-of-way line of S.R. 430 (Carson-Reno Highway); thence along said U.S. 395 Freeway and S.R. 430 right-of-way lines, which are coincident with the easterly boundary line of said PARCEL 2, the following three (3) courses and distances:

- 1) N. 61°06'02" W. - 20.00 feet;
- 2) S. 28°53'58" W. - 456.19 feet;
- 3) from a tangent which bears the last described course, curving to the left with a radius of 2,980 feet, through an angle of 6°54'23", an arc distance of 359.21 feet to the southeast corner of said PARCEL 2;

thence N. 81°54'07" W., along said southerly boundary line of PARCEL 2, which is coincident with said easterly right-of-way line of U.S. 395 Freeway, a distance of 181.13 feet to the point of beginning; said parcel contains an area of 4.28 acres (186,505 square feet).

TOGETHER with all and singular the tenements, hereditaments and appurtenances thereunto belonging, or in anywise appertaining, and the reversion and reversions, remainder and remainders, rents, issues and profits thereof; with the exception of any and all reservations as are previously hereinabove expressly excepted from this conveyance.

TO HAVE AND TO HOLD all and singular the said real property, together with the appurtenances, unto the said GRANTEE and to any heirs, successors and assigns forever.

. . .
. . .
. . .
. . .
. . .
. . .

BK5095PG0821

IN WITNESS WHEREOF said GRANTOR has hereunto signed on the day and year first above written.

Dennis Sayan
DENNIS SAYAN

Penny Sayan
PENNY SAYAN

STATE OF NEVADA)
COUNTY OF Washoe) ss.

On this 23 day of December, 19 97,
personally appeared before me, the undersigned, a Notary Public
in and for the County of Washoe, State of Nevada,

Dennis Sayan + Penny Sayan
personally known (or proved) to me to
be the persons whose name is subscribed to the above instrument
and who acknowledged to me that they executed the same freely
and voluntarily and for the uses and purposes thereby mentioned.

S
E
A
L

IN WITNESS WHEREOF I have hereunto set
my hand and affixed my official seal the day
and year in this certificate first above
written.

Trish A. McEwen



BK50955PG0822

2168627

2:00 pm

JAN 07 1998

OFFICIAL RECORDS, WASHOE COUNTY, NEVADA
Record Requested by
FIRST AMERICAN TITLE COMPANY OF NEVADA
COUNTY RECORDER
FEE 0 DEPUTY *JH*

2186

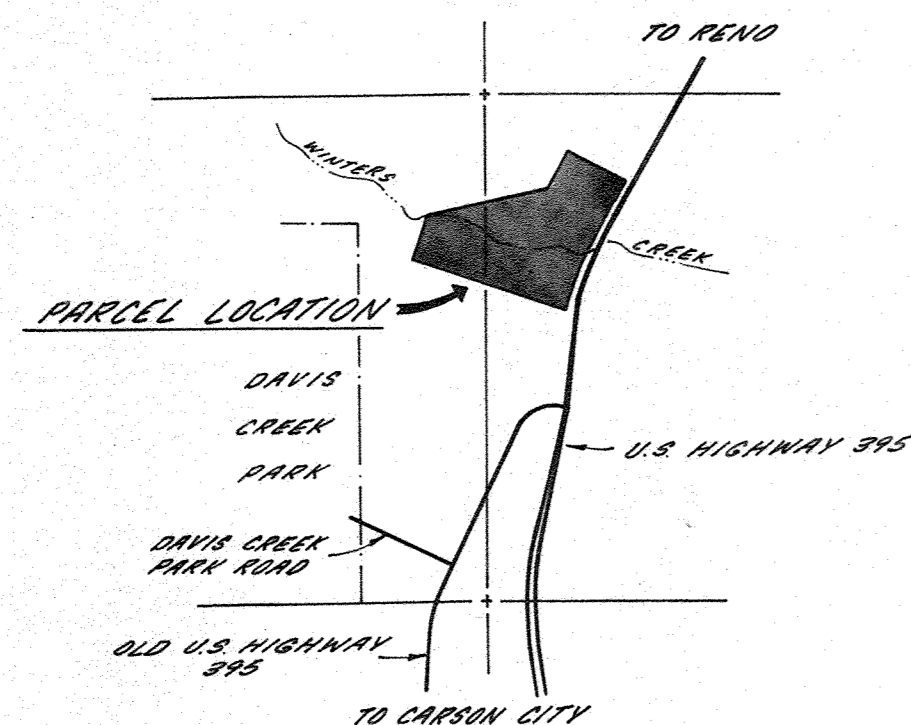
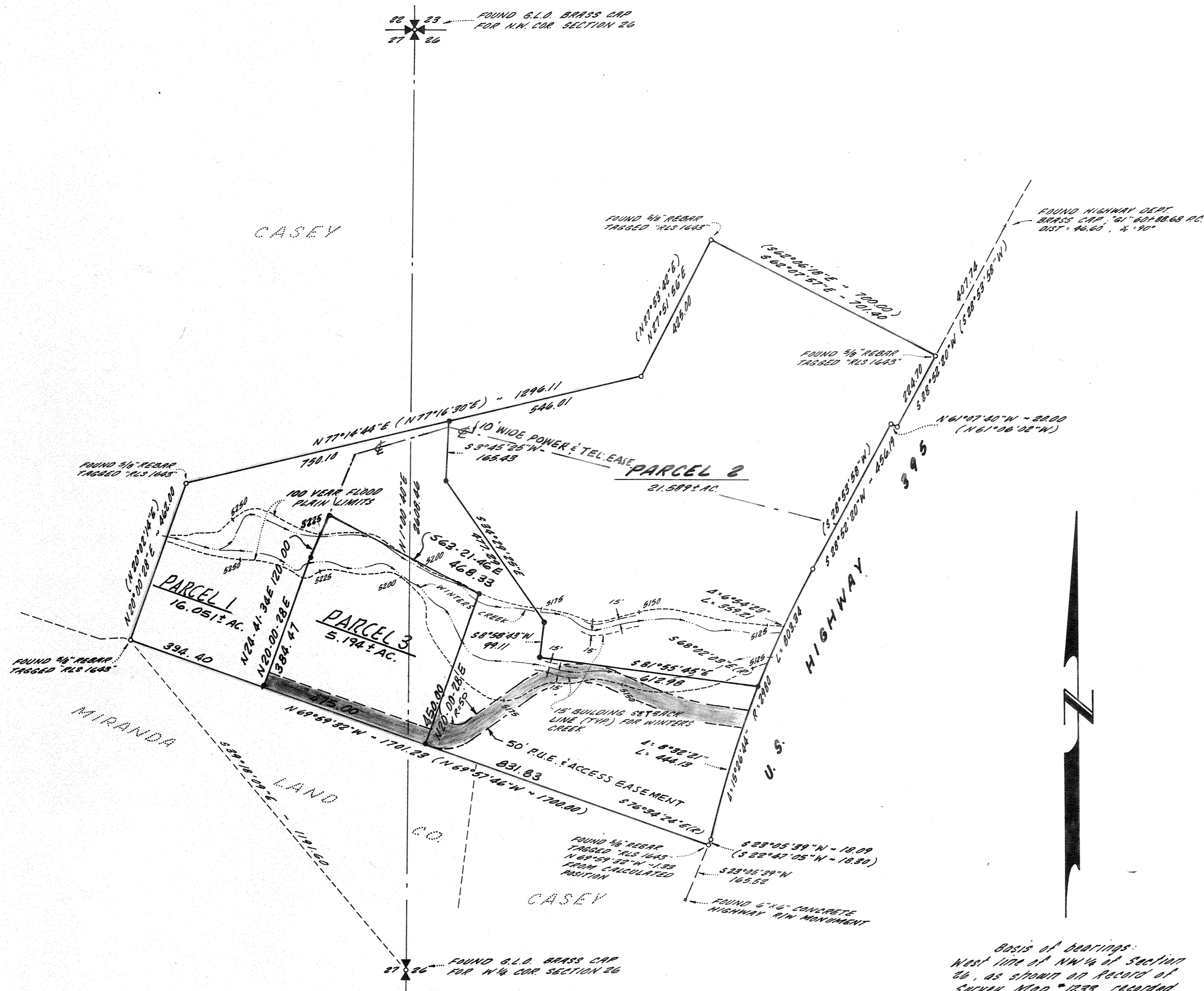

SECTIONS 26 & 27, T.17N., R.19E., M.D.B. & M.
VICINITY MAP
SCALE: 1" = 200'

LEGEND

- set 3/4" rebar with cap stamped "R.L.S. 686"
- public utility easement
- () record data

AREA TABULATION

Parcel 1	16.051 AC
Parcel 2	21.589 AC
Parcel 3	5.194 AC
Total	42.834 AC

Basis of bearings:
West line of NW 1/4 of Section 26, as shown on Record of Survey Map 1255, recorded Sept. 26, 1978, i.e. N 17°00'00"E

NOTES

A public utility easement is hereby granted within each parcel for the exclusive purpose of installing and maintaining utility service facilities to that parcel at locations mutually agreed upon by the owner of record at the time of installation and the utility company.

A 25' R.U.E. is granted along U.S. Highway 395, a 5' R.U.E. is granted along the exterior boundary of the parcels; a 25' R.U.E. is granted along interior parcel lines.

A portion of this division is located within a federally designated floodplain and must therefore comply with the Washoe County Flood Hazard Reduction Ordinance. All new structures within the flood plain must be flood bracketed and the finished floor must be one foot above the 100 year flood surface elevation.

The natural drainage of Washoe Creek will not be impeded during improvement or development of these parcels.

OWNER'S CERTIFICATE

This is to certify that the undersigned Michael D. and Peggy L. Savan; and Myron B. Savan are the owners of that tract of land represented on this plan and have consented to the preparation and recording of this plan and that the same is executed in compliance with and subject to the provisions of NRS Chapter 278. The access and public utility easements as shown hereon are hereby granted.

Michael D. Savan
Michael D. Savan
Peggy L. Savan
Peggy L. Savan

Myron B. Savan
Myron B. Savan

State of Nevada ss
County of Washoe ss
On this 9th day of April, 1987, personally appeared before me, a Notary Public in the County of Washoe, Nevada, Michael D. and Peggy L. Savan, and Myron B. Savan, who acknowledged to me that they executed the above instrument, in witness whereof, I hereunto set my hand and affix my seal on the day and year first written above.

MUSAM B. HANNAH
NOTARY PUBLIC, NEVADA
WASHOE COUNTY
My Exp. Expires April 7, 1990

Susan B. Hannah
Notary Public

SURVEYOR'S CERTIFICATE

I, Eugene B. Longfield, a Registered Land Surveyor in the State of Nevada, certify that:

- This is a true and accurate representation of the lands surveyed under my supervision at the instance of Michael D. and Peggy L. Savan, and Myron B. Savan.
- The lands surveyed lie within the NW 1/4 of Section 26, and the NE 1/4 of Section 27, T.17N., R.19E., M.D.B. & M.; and the survey was completed on February 5, 1987.
- This plan complies with the applicable state statutes and any local ordinances.
- The monuments shown are of the character shown and occupy the positions indicated and are sufficient to enable the survey to be retraced.

Eugene B. Longfield
REGISTERED LAND SURVEYOR - STATE OF NEVADA
No. 886

UTILITY COMPANIES CERTIFICATE

The utility easements shown on this plan have been checked, accepted, and approved by the undersigned public utility companies:

R.E. Shuman
Sierra Pacific Power Co.
J.W. Pentka
Nevada Bell

4-29-87
Date
5/1/87
Date

COUNTY COMMISSIONERS' CERTIFICATE

Approved and accepted by the Board of County Commissioners of Washoe County, Nevada, on this 8th day of September, 1987.

Julie F. Dailey
County Clerk

FILE NO. 1191340 Fee: \$10.⁰⁰

Filed for record at the request of LONGFIELD ENG. on this 10th day of SEPTEMBER, 1987, at 10:00 minutes past 2 o'clock, P.M.; Official Records of Washoe County, Nevada.

Joe Wetcher
County Recorder

By: J. Soderman
Deputy

PARCEL MAP
for
MICHAEL D. and PEGGY L. SAVAN
and **MYRON B. SAVAN**
being portions of the NW 1/4 of Section 26, and the NE 1/4 of Section 27, T.17N., R.19E., M.D.B. & M. Washoe County, Nevada
Scale: 1" = 200' sheet 1 of 1 March, 1987

1191340

Parcel Map 2186

PREPARED BY LONGFIELD ENGINEERING
RENO, NEVADA

FOR SUBSEQUENT CHANGES TO THIS MAP

POR. SEC.'S 26 & 27
T. 17 N. - R. 19 E.

46-05

N 62° 34' 52" E
1139.56' TO N 1/4 COR

BK.
48

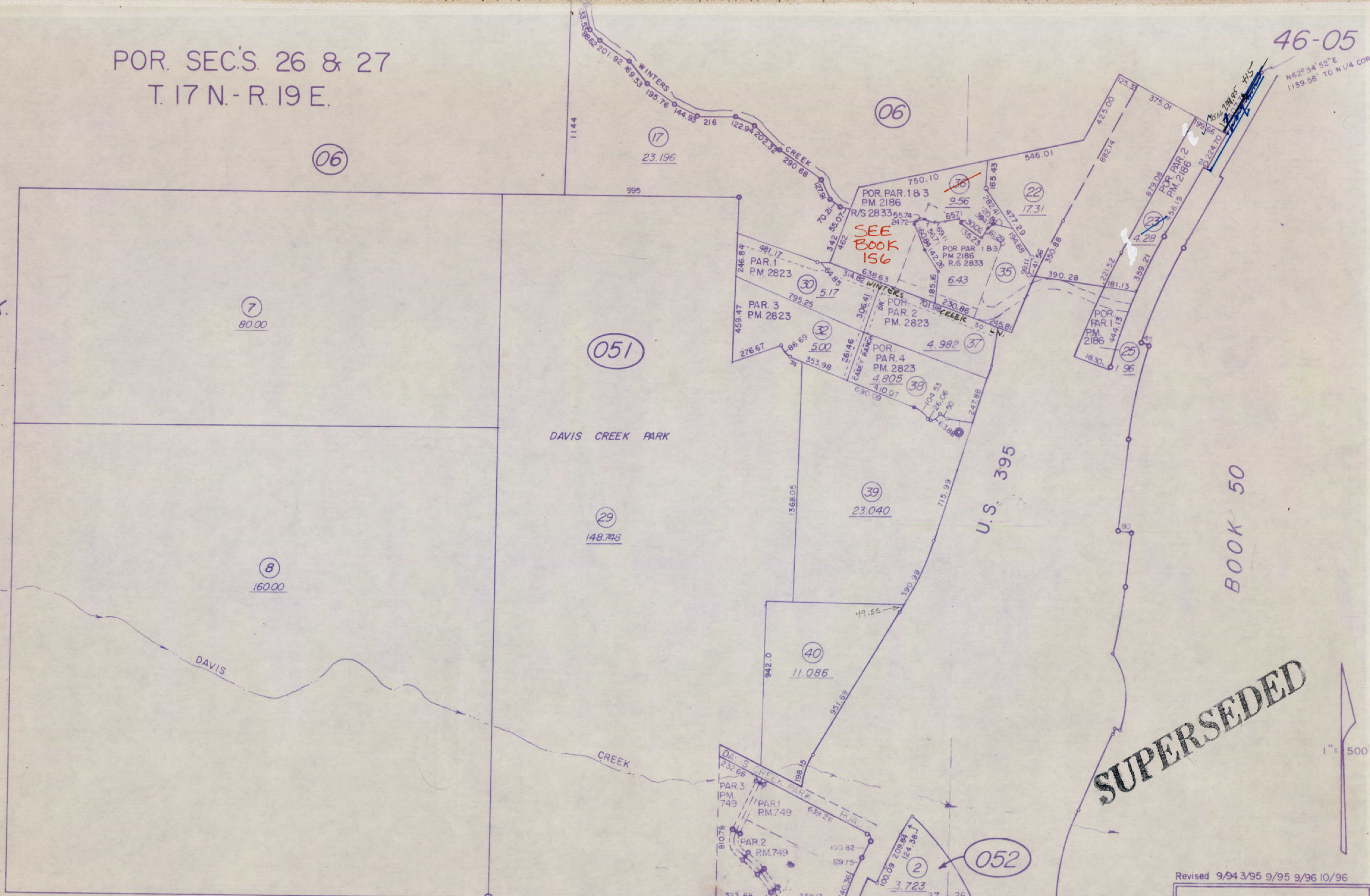

NOTE This Map is prepared for the use of the Washoe County Assessor for Assessment and illustrative purposes only, it does not represent survey of the premises. No liability is assumed as to the sufficiency or accuracy of the data delineated hereon.

NOTE - ASSESSOR'S BLOCK NUMBERS SHOWN IN ELLIPSES
ASSESSOR'S PARCEL NUMBERS SHOWN IN CIRCLES

Revised 9/94 3/95 9/95 9/96 10/96

drawn by MARY CRAIG 10/78

WMPA18-0009 & WRZA18-0008
superseded 8/2 EXHIBIT D

Situs & Keyline Description:
1135 US HIGHWAY 395 S WASHOE COUNTY
FR SEC 26 TWP 17 RGE 19

Owner & Mailing Address:
UNITED STATES OF AMERICA
NONE
RENO, NV 00000

WASHOE COUNTY APPRAISAL RECORD 2019

APN: 050-210-37

Card 1 of 2
Bld. 1-1



Tax District: 4000

printed: 12/03/2018

ACTIVE

5930.25

IBYY - Government Owned

VALUATION HISTORY							PARCEL VALUE SUMMARY				Database	Roll Year	Prior % Complete	% Complete			
Roll Year	Taxable Land	Land New	Taxable Improvements	Improvement New	Total Taxable	Total Assessed	Primary Valuation	Building Level Cost		PROD							
							Building Value										
2019 VN	113,149	0	0	0	113,149	39,602	Extra Feature Value										
2018 FV	113,149	0	0	0	113,149	39,602	Land Value	113,149									
2017 FV	113,149	0	0	0	113,149	39,602	Taxable Value	113,149									
2016 FV	113,149	0	0	0	113,149	39,602	Exemption	113,149				Reopen	Code:				
2015 FV	113,149	0	0	0	113,149	39,602	FLAGS										
2014 FV	113,149	0	0	0	113,149	39,602	Type	Value				Reappraisal					
2013 FV	113,149	0	0	0	113,149	39,602	Cap Code	NFM									
2012 FV	113,149	0	0	0	113,149	39,602	Eligible for Form?	NO				NC / C	New Land	New Sketch			
2011 FV	113,149	0	0	0	113,149	39,602	Low Cap Percentage	0									
2010 FV	113,100	0	0	0	113,100	39,585	Revisit	PPID				By:	Date:				
2009 FV	96,135	0	0	0	96,135	33,647											
2008 FV	2,828,700	0	0	0	2,828,700	990,045											
BUILDING DETAILS				BUILDING FEATURES AND ADJUSTMENTS				BUILDING SUB-AREAS				BUILDING COST SUMMARY					
Type	Code	Description	Category	Units	Code	Description	Yr Bld	Units	Cost New	Tot Lump Sum Adj							
Occupancy	004	Residential Conversion ~	Plumbing Fixtures	11	1FL	1FLR - FIRST FLOOR		1,802	152,954	26,657	203,517						
Story/Frame	01	SINGLE STORY	Base Appliance From MS	1	GRA	GARA - GARAGE ATTACHED		208	6,910		Sub Area-RCN						
Quality	25	Fair-Average	Units	1	PRM	PRF2 - PORCH ROOF METAL		595	6,129		% Incomplete						
Year Built	1990		Bath - Full	2	STR	STRM - STORAGE ROOM		90	3,424		% Depreciation						
WAY	0		Bath - Half	1	WDW	WDK1 - WOOD DECK WOOD		595	7,443		\$ Dep & Inc						
%Comp	0		Base Rate Adjustment				Adj.				Obso/Other Adj.						
Year of Addn/Remodel			CCM SFR Frame				1.05000				Sub Area DRC						
Category	Code	Type	Local Reno Frame				1.05000				Additive DRC						
Ext. Wall	2	PLYWOOD/FR ~	Construction Modifiers				Adj.				Total DRC						
Roof Cover	8	METAL ~ METAL									Override						
Base	1	MS FLOOR ADJ									Cost Code						
Heating Type	11	FA/AC ~									89502						
Sub Floor	2	WOOD									PROPERTY CHARACTERISTICS						
Energy	3	MODERATE ~									Special Prop Code						
Foundation	3	MODERATE ~									Water						
Seismic	1	SEISMIC FRAME									Sewer						
										BUILDING NOTES							
										IMPS ON ADJACENT PARCEL TO THE WEST (PPID ACCOUNT NOT BILLED 2012). RJS 9/11/15							
										Gross Living/Building Area							
										Perimeter							
										1,802							
										194							
#	Bld	Date	User ID	Activity Notes													
1	0-0	11/08/2018	aclancy	REXT BY AH - 09/25/2018													
EXTRA FEATURES, ADDITIVES, AND ADJUSTMENTS																	
#	Code	Description	Quality	Bld #	Length	Width	Units	Unit Price	Year Built	Roll Year	% Comp	RCN	% Good	DRC	Override Value	Notes	
1	FPS1	FIREPLACE SINGLE 1 STORY	EBLD	1-1	0	0	1	3,764.85	1990		0	3,765	0.0	0			
2	WPRS	WELL, PRESSURE SYSEM & SEPTIC	30	1-1	0	0	1	11,088.00	1990		0	11,088	0.0	0			
3	YIMP	YARD IMPROVEMENTS	30	1-1	0	0	1	1,593.78	1990		0	1,594	0.0	0			
LAND VALUE		DOR Code	Neighborhood	Land Size				Unit Type									
100		5930.25	IBYY - Government Owned	113.1490				AC									
#	Code	Description	Zone	Units	Unit Type	Sub Type	Unit Price	Influence 1 Code	Influence 1 %	Influence 2 Code	Influence 2 %	Taxable Value	Land Notes				
1	100	Vacant, other or unknown	OS	113.15	AC		1,000.00					113,149					

WMPA18-0009 & WRZA18-0008

EXHIBIT D

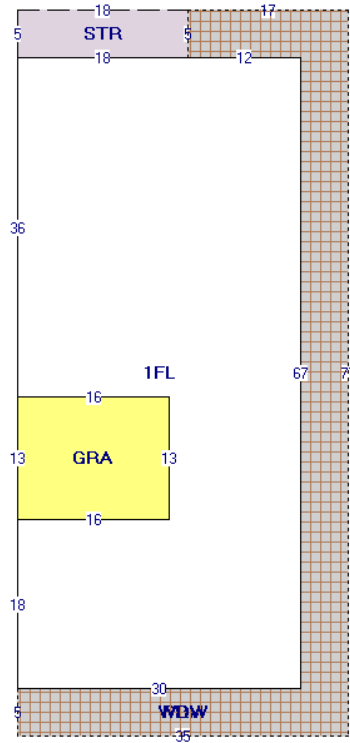

BUILDING PERMITS

Date	Permit #	Description	Amount	Status	% Comp	Last Visit/Appr/Results	Notes

SALES/TRANSFER INFORMATION

Grantor	Document	Date	LUC	Verif	Terms	Sales	Notes
UNITED STATES OF CONSERVATION FUND	2780301	12/23/2002	PAS1	3MNT			
	2753502	10/24/2002	PAS1	3NTT			
FALCON CAPITAL LLC,	2540799	04/05/2001	120	2MQC	1CTS	7,500,000	A SEE 050-210-06
	2405081	12/10/1999	120	1GCR	1CTS	558,379	A VERIFIED AT T.C.

#	Bld	Date	User ID	Activity Notes
2	0-0	09/26/2017	smans	REXT BY AH - 08/31/2017
3	0-0	10/03/2016	rlope	REXT BY DRS - 09/07/2016
4	0-0	03/10/2016	mluns	DELETE APRO SKETCH
5	0-0	03/10/2016	mluns	DELETE APRO SKETCH
6	0-0	11/16/2015	sjack	REXT BY X - OCTOBER, 2015
7	0-0	11/05/2015	sjack	REXT BY DRS - OCTOBER, 2015
8	1-1	09/26/2014	PRCL	IMPS ON ADJACENT PARCEL TO THE WEST (PPID ACCOUNT NOT BILLED 2012).
10	0-0	11/14/2013	prcl	IMPS ON ADJACENT PARCEL TO THE WEST (PPID ACCOUNT NOT BILLED 2012).
11	1-1	09/18/2013	drsta	REXT IBYY IMPROVEMENT LINE DONE 09/18/2013 BY REVIEWED-NO CHGS ON IMP

This information is for use by the Washoe County Assessor for assessment purposes only.

Situs & Keyline Description:
1135 US HIGHWAY 395 S WASHOE COUNTY
FR SEC 26 TWP 17 RGE 19

Owner & Mailing Address:
UNITED STATES OF AMERICA
NONE
RENO, NV 00000

WASHOE COUNTY APPRAISAL RECORD
2019

APN: 050-210-37

Card 2 of 2
Bld. 2-1



Tax District: 4000

printed: 12/03/2018

ACTIVE

5930.25

IBYY - Government Owned

VALUATION HISTORY							PARCEL VALUE SUMMARY				Database	Roll Year	Prior % Complete	% Complete
Roll Year	Taxable Land	Land New	Taxable Improvements	Improvement New	Total Taxable	Total Assessed	Primary Valuation	Building Level Cost		PROD				
							Building Value							
2019 VN	113,149	0	0	0	113,149	39,602	Extra Feature Value							
2018 FV	113,149	0	0	0	113,149	39,602	Land Value	113,149						
2017 FV	113,149	0	0	0	113,149	39,602	Taxable Value	113,149						
2016 FV	113,149	0	0	0	113,149	39,602	Exemption	113,149				Reopen	Code:	
2015 FV	113,149	0	0	0	113,149	39,602	FLAGS							
2014 FV	113,149	0	0	0	113,149	39,602	Type	Value				Reappraisal		
2013 FV	113,149	0	0	0	113,149	39,602	Cap Code	NFM						
2012 FV	113,149	0	0	0	113,149	39,602	Eligible for Form?	NO				NC / C	New Land	New Sketch
2011 FV	113,149	0	0	0	113,149	39,602	Low Cap Percentage	0						
2010 FV	113,100	0	0	0	113,100	39,585	Revisit	PPID				By:	Date:	
2009 FV	96,135	0	0	0	96,135	33,647								
2008 FV	2,828,700	0	0	0	2,828,700	990,045								

BUILDING DETAILS				BUILDING FEATURES AND ADJUSTMENTS				BUILDING SUB-AREAS				BUILDING COST SUMMARY			
Type	Code	Description	Category	Units	Code	Description	Yr Bld	Units	Cost New	Tot Lump Sum Adj					
Occupancy	001	RESidential	Plumbing Fixtures	11	1FL	1FLR - FIRST FLOOR		1,764	135,828	24,689	220,196				
Story/Frame	02	Sgl Fam Res ~	Base Appliance From MS	1	2FL	2FLR - SECOND FLOOR		390	30,030		100				
Quality	25	TWO STORY	Living Units in Building	1	DRO	DO - No Value Drawn for Info		60	0		43.50				
Year Built	1990	Fair-Average	Bedrooms	2	PRM	PRF2 - PORCH ROOF METAL		1,047	10,784		220,196				
WAY	1990	%Comp	Bath - Full	2	STR	STRM - STORAGE ROOM		105	3,994		0				
Year of Addn/Remodel	0		Bath - Half	1	WDW	WDK1 - WOOD DECK WOOD		1,419	14,871		0				
BUILDING CHARACTERISTICS				Base Rate Adjustment				Gross Living/Building Area				BUILDING NOTES			
Category	Code	Type	%	Adj.			2,154		IMPS ON ADJACENT PARCEL TO THE WEST (PPID ACCOUNT NOT BILLED 2012). RJS 9/11/15						
Ext. Wall	2	PLYWOOD/FR ~	100		CCM SFR Frame		1.05000		APN 050-210-37 1135 S US 395 N CC HWY						
Roof Cover	8	METAL ~ METAL	100		Local Reno Frame		1.05000								
Base	1	MS FLOOR ADJ	100		Construction Modifiers		Adj.								
Heating Type	1	FA ~ FORCED	100												
Sub Floor	2	WOOD	100												
Energy	3	MODERATE ~	100												
Foundation	3	MODERATE ~	100												
Seismic	1	SEISMIC FRAME	100												
							Perimeter		254						

#	Bld	Date	User ID	Activity Notes
9	2-1	09/26/2014	PRCL	IMPS ON ADJACENT PARCEL TO THE WEST (PPID ACCOUNT NOT BILLED 2012).

EXTRA FEATURES, ADDITIVES, AND ADJUSTMENTS																
#	Code	Description	Quality	Bld #	Length	Width	Units	Unit Price	Year Built	Roll Year	% Comp	RCN	% Good	DRC	Override Value	Notes
4	FPS2	FIREPLACE SINGLE 2 STORY	EBLD	2-1	0	0	1	4,680.65	1990		0	4,681	0.0	0		
5	FWCO	FLATWORK CONCRETE	30	2-1	0	0	300	6.15	1990		0	1,846	0.0	0		
6	SHD3	SHED WOOD	30	2-1	0	0	192	22.88	1990		0	4,393	0.0	0		
7	STR2	STAIRS WOOD (Make note in sketch)	30	2-1	0	0	1	1,510.00	1990		0	1,510	0.0	0		
8	YIMP	YARD IMPROVEMENTS	30	2-1	0	0	1	1,593.78	1990		0	1,594	0.0	0		

LAND VALUE	DOR Code	Neighborhood	Land Size	Unit Type
100	5930.25	IBYY - Government Owned	113.1490	AC

#	Code	Description	Zone	Units	Unit Type	Sub Type	Unit Price	Influence 1 Code	Influence 1 %	Influence 2 Code	Influence 2 %	Taxable Value	Land Notes

WMPA18-0009 & WRZA18-0008

EXHIBIT D

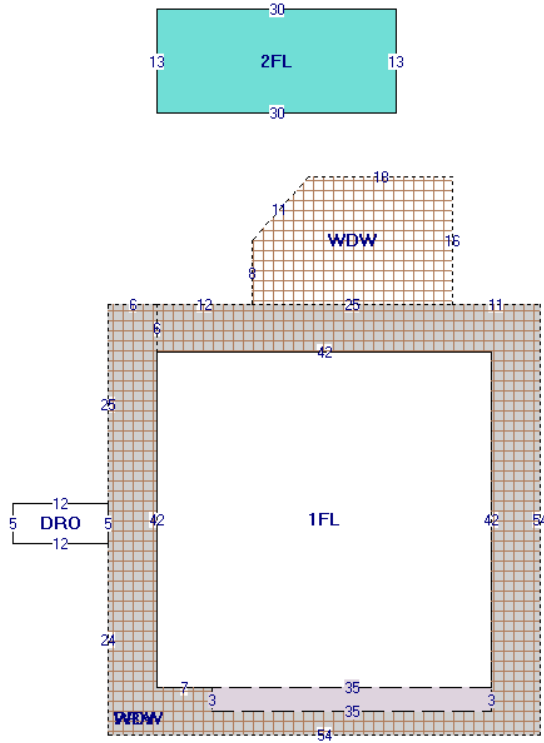

BUILDING PERMITS

Date	Permit #	Description	Amount	Status	% Comp	Last Visit/Appr/Results	Notes

SALES/TRANSFER INFORMATION

Grantor	Document	Date	LUC	Verif	Terms	Sales	Notes
UNITED STATES OF CONSERVATION FUND	2780301	12/23/2002	PAS1	3MNT			
	2753502	10/24/2002	PAS1	3MNT			
FALCON CAPITAL LLC,	2540799	04/05/2001	120	2MQC	1CTS	7,500,000	A SEE 050-210-06
	2405081	12/10/1999	120	1GCR	1CTS	558,379	A VERIFIED AT T.C.

#	Bld	Date	User ID	Activity Notes



South Truckee Meadows/Washoe Valley Citizen Advisory Board

DRAFT: Approval of these draft minutes, or any changes to the draft minutes, will be reflected in writing in the next meeting minutes and/or in the minutes of any future meeting where changes to these minutes are approved by the CAB. Minutes of the regular meeting of the South Truckee Meadows/Washoe Valley Citizen Advisory Board held January 3, 2019 6:00 p.m. the South Valleys Library at 15650A Wedge Parkway, Reno, Nevada.

1. *CALL TO ORDER/ DETERMINATION OF QUORUM - Meeting was called to order at by Patricia Phillips at 6:00 p.m.

Member Present: Patricia Phillips, Kimberly Rossiter, Tom Burkhart, Shaun O’Harra. A quorum was determined.

Absent: Jim Rummings (excused), Bob Vaught (alternate, not excused).

2. *PLEDGE OF ALLEGIANCE - Patricia Phillips led the Pledge of Allegiance.

3. *PUBLIC COMMENT - No public comments were made.

7. DEVELOPMENT PROJECTS– The project description is provided below.

7.A. Master Plan Amendment Case Number WMPA18-0009 and Regulatory Zone Amendment WRZA18-0008–

Request for community feedback, discussion and possible action to forward community and Citizen Advisory Board comments to Washoe County staff on a request:

(1) To adopt an amendment to the South Valleys Area Plan, a component of the Washoe County Master Plan, to add the Master Plan Category of Rural (R) on a ±2.56 acre parcel that was previously part of the Nevada State Department of Transportation (NDOT) right-of-way and currently has no assigned Master Plan Category; and

(2) Subject to final approval of the associated Master Plan Amendment, to recommend adoption of an amendment to the South Valleys Regulatory Zone Map, to add the Regulatory Zone of General Rural (GR) on a ±2.56 acre parcel that was previously part of the Nevada State Department of Transportation (NDOT) right-of-way and currently has no assigned Regulatory Zone. (for Possible Action)

- Applicant/Property Owner: Washoe County/Michael L D & Penny Sayan
- Location: Between I-580 & US395 and adjacent to the west of 1020 US Highway 395 S
- Assessor’s Parcel Number: 046-051-49
- Staff: Julee Olander, Planner, 775-328-3627; jolander@washoecounty.us
- Reviewing Body: Tentatively scheduled for the Planning Commission on February 5, 2019

Julee Olander, Planner, provided a project overview:

- The goal of this case is to bring this property back under Washoe County jurisdiction instead of NDOT right-a-way.
- Master Plan would be amended to Rural (R) and add the regulatory zone General Rural (GR).
- There are two houses on the property which are in disrepair.
- There is a well and septic on the property which restricts any commercial type uses. The owner has indicated that he is ok with GR zoning designation.

- The designation requires 40 acres and this lot would not be conforming as it doesn't meet the minimum size.
- If the property owner wants to re-zone the property commercial he would need to come back before this board.
- It's a right-in, right-out access.
- They can live on the property that the property owner is refurbishing.

Tom Burkhart asked the impetuosity of the change. Julee Olander said NDOT doesn't need the property anymore. Mr. Sayan was able to purchase the property back.

Dennis Sayan, property owner, said he built property 25 years ago, NDOT thought they needed it when they built the freeway, and took the property. It is surplus land. He has been working on acquiring the property back. Mr. Sayan said he has 1,000 feet of road frontage. He said he would like to use it for a nursery, kennel, or have someone come in and enjoy wine by the pond. He spoke about water and sewer. There are a lot of properties on septic and well. It would need to get a special use permit for some commercial uses. He said he wants to keep this property open for the public. He said if the property needs to be brought up to standard, he will do that. He said it was a home, duplex.

Patricia Phillips asked if there were any other options for other zoning. Ms. Olander said he is constrained due to septic on the property and being in the TMSA. She said there is a conversation happening about little Washoe City area. Currently, there are no other avenues for other zoning. There is opportunity for future discussion about other zoning. The health department doesn't allow commercial on properties with septic. The current septic wasn't built for commercial use.

Bill Naylor said the county has made a point not to make fragmented zoning. He spoke about zoning designations. High density rural for 2.5 acre parcel would be acceptable. It would be rural and consistent with this property. Marijuana property is on a closed system per regulation.

Mr. Sayan said he appreciate exploring alternative zoning. He said it's a unique property as it sits on US Highway 395 with 1000 feet of frontage road. Mr. Sayan said we need to bring people into that area and not sit dark at night. There are other properties with septic that are commercial and this one should be grandfathered in.

MOTION: Tom Burkhart moved to recommend approval Master Plan Amendment Case Number WMPA18-0009 and Regulatory Zone Amendment WRZA18-0008. Kimberly Rossiter seconded the recommendation for approval. Motion passed unanimously.

8. *PUBLIC COMMENT – There were no requests for public comment.

ADJOURNMENT – the meeting adjourned at 7:26 p.m.

Number of CAB members present: 4

Number of Public Present: 20

Presence of Elected Officials: 0

Number of staff present: 2

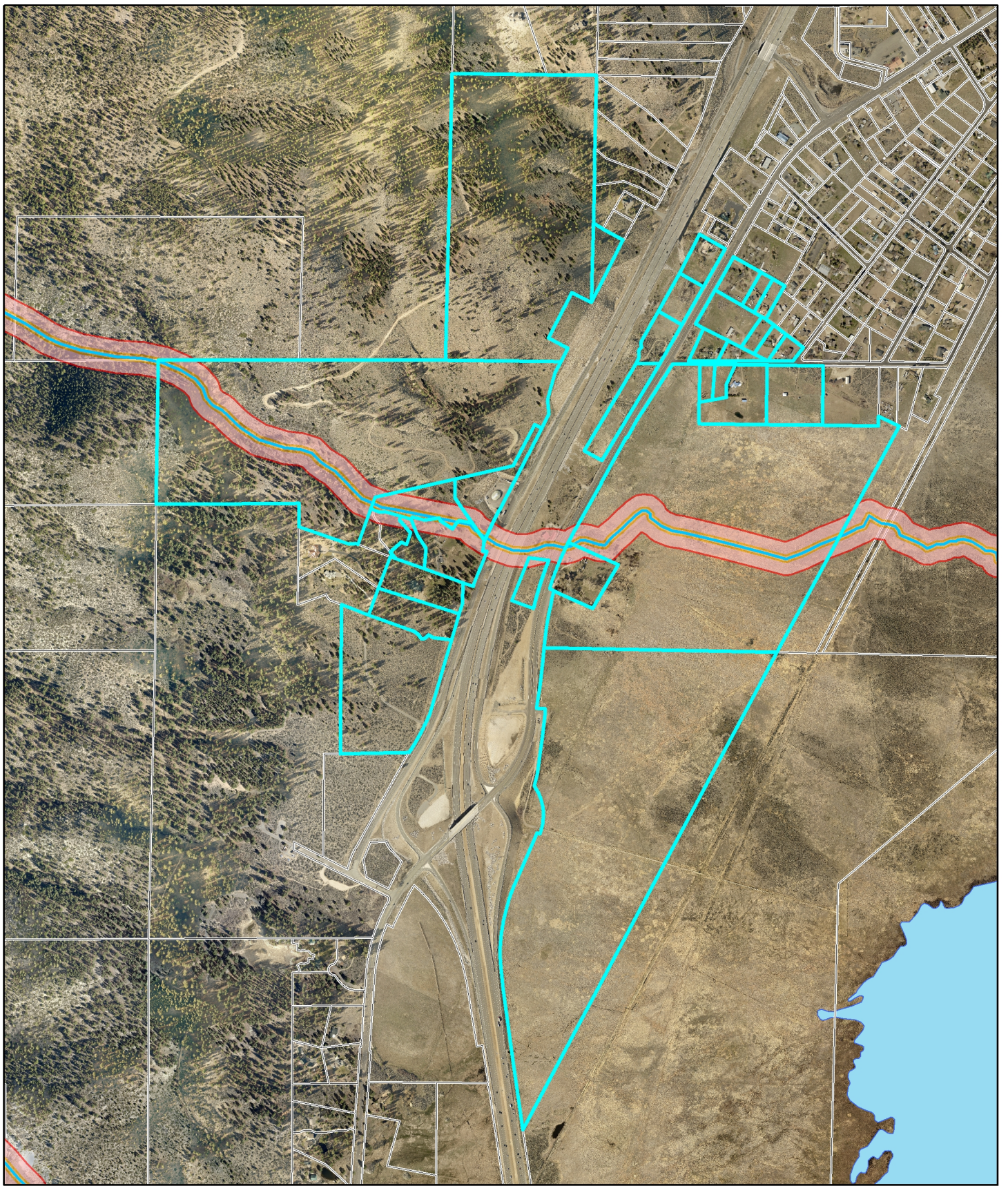

WMPA18-0009 & WRZA18-0008
Noticing Map
31 Property Owners Noticed

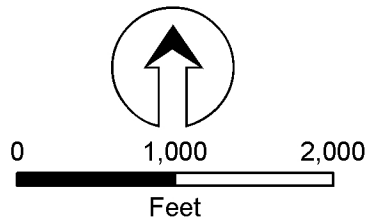

Community Services
Department

WASHOE COUNTY
NEVADA

Post Office Box 11130
Reno, Nevada 89520 (775) 328-3600

Source: Planning and Building Division

Date: January 2019

From: [Rubio, Wesley S](#)
To: [Olander, Julee](#)
Subject: RE: Request for comments for MPA & RZA for newly created parcel
Date: Thursday, November 29, 2018 8:32:07 AM
Attachments: [image006.png](#)
[image007.png](#)
[image008.png](#)
[image009.png](#)
[image010.png](#)
[image011.png](#)

Hi Julee,

WCHD doesn't have any objections to this moving forward as proposed below. The site has an existing septic and well that have been permitted through WCHD. The only item to ensure is that the well serving the house is on the same parcel as the SFD, or they will need to get additional review and approval from DWR (Division of Water Resources) with the State.

wes

From: Olander, Julee
Sent: Tuesday, November 20, 2018 1:51 PM
To: Vesely, Leo; Klein, Kris; Smaltz, Tara M; English, James; Rubio, Wesley S; Beaver, Lisa; Coon, Don; Rebecca Kapuler
Cc: Lloyd, Trevor
Subject: Request for comments for MPA & RZA for newly created parcel

The Washoe County Planning and Building Division has received a request to establish master plan designation and regulatory zoning for a newly created 2.56 acre parcel (APN: 046-051-49) that was previously part of NDOT right-of-way (see map below). A master plan and regulatory zone amendment are being initiated to resolve and create the master plan designation and zoning for this parcel. There is an existing house on the property with a well and septic. The proposal is to designate the parcel Rural (R) and with a zoning of General Rural (GR). This zoning will create a non-conforming parcel however, this designation and zoning will match with the designation and zoning of the parcel to the north. The County is bringing this request forward to the Planning Commission and then if approved the Board of County Commissioners and the Regional Planning Commission. This being a MPA an RZA you can only comment, the request cannot be conditioned. Please let me know if you have any comments for this request or if you need more information and please provide your comments by December 4th.



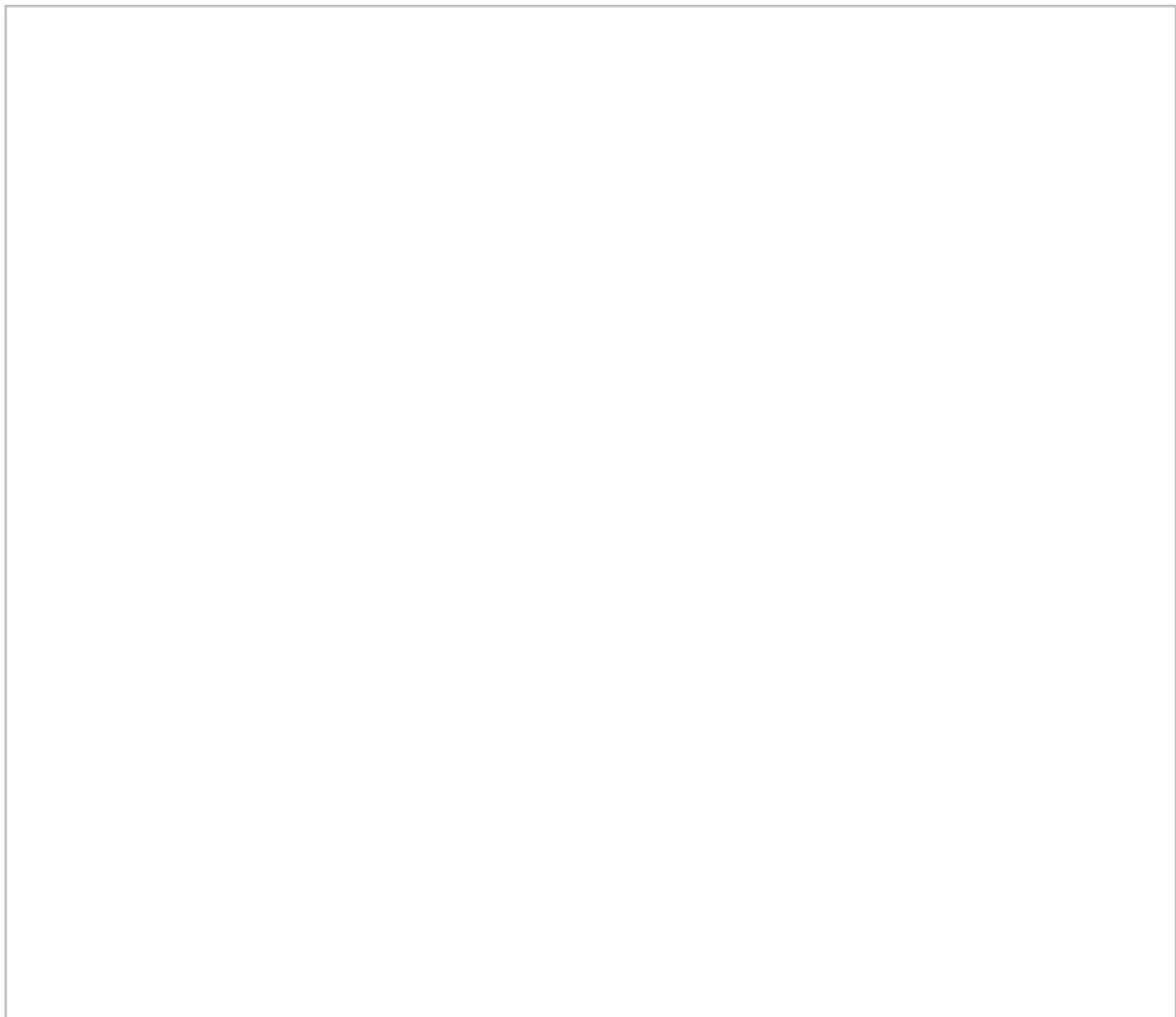

Thank you,



Julee Olander
Planner | Community Services Department- Planning & Building Division
jolander@washoecounty.us | Office: 775.328.3627 | Fax: 775.328.6133
1001 E. Ninth St., Bldg A., Reno, NV 89512



Connect with us: [cMail](#) | [Twitter](#) | [Facebook](#) | www.washoecounty.us